

# SOJAG

produits saisonniers • seasonal products

QUESTIONS? 1 866-901-1649

## Assembly Manual / Guide d'assemblage / Manual de ensamblaje / 조립설명서 / Montageanleitung

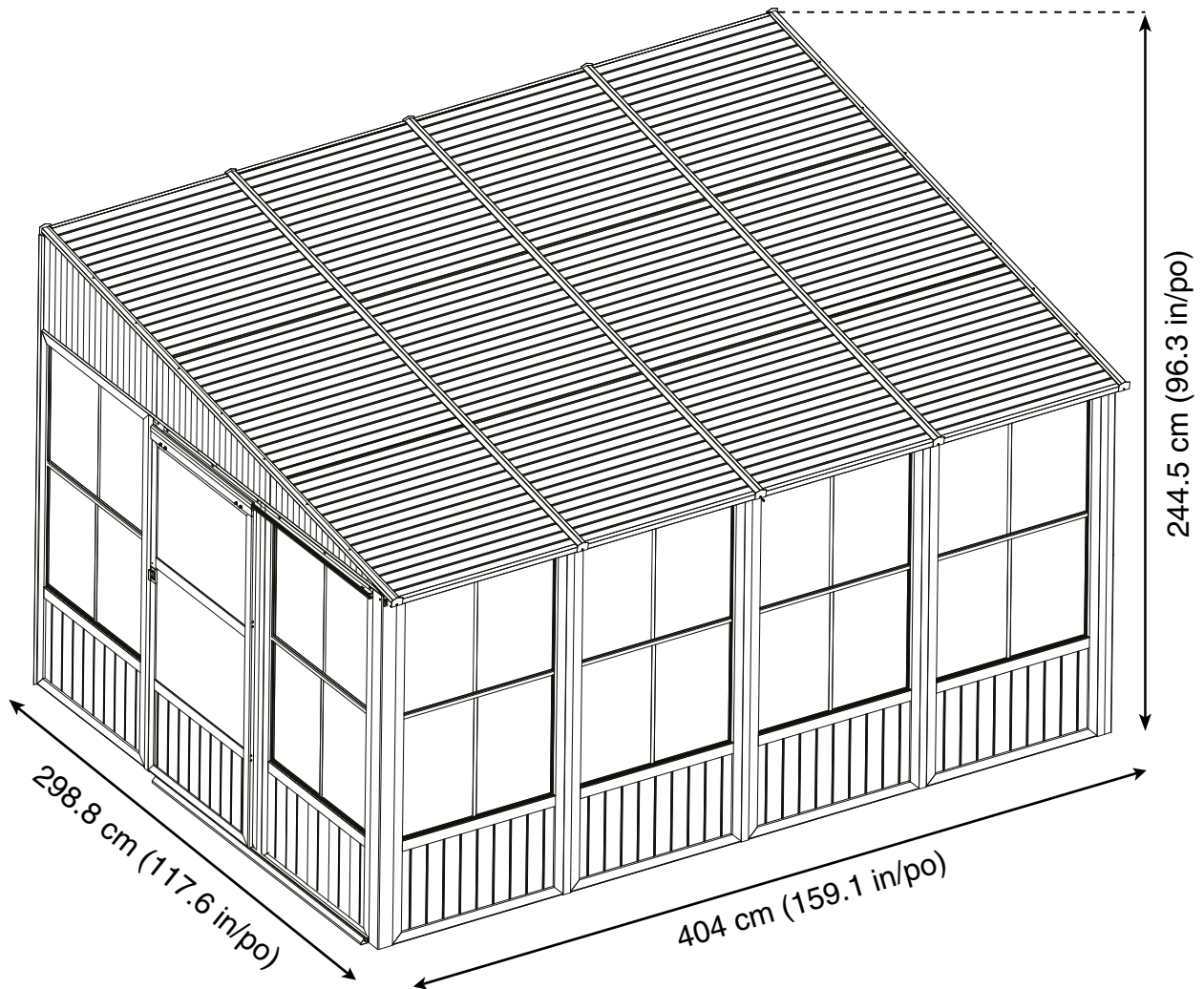

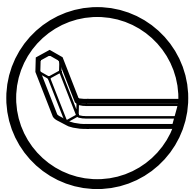

Use the hex keys in the box. / Utilisez les clés hexagonales fournies dans la boîte. / Utilice las llaves hexagonales en la caja. / 상자에 육각 키를 사용 하십시오. / Verwenden Sie die Sechskantschlüssel in der Box.

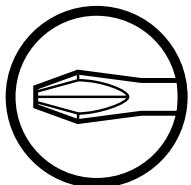

Please use a Phillips screwdriver. / Utilisez un tournevis de type Phillips / Por favor, use un destornillador Phillips. / 십자 드라이버를 사용 하십시오. / Bitte verwenden Sie einen Kreuzschraubenzieher.

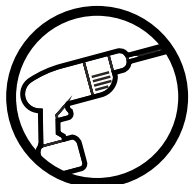

You may need to use a drill for this step. / Vous pouvez avoir besoin d'utiliser une perceuse pour cette étape. / Puede que tenga que utilizar un taladro para este paso. / 이 단계에선 드릴을 사용해야 할 수도 있습니다. / Für diesen Schritt können Sie einen Bohrer verwenden.



Wearing protective gloves is recommended. / Le port de gants de protection est recommandé / El uso de guantes de protección se recomienda. / 보호 장갑을 착용 하는 것이 좋습니다. / Das Tragen von Schutzhandschuhen wird empfohlen.



Two or more people are required at this stage. / Deux personnes ou plus sont nécessaires à cette étape. / Dos o más personas se requieren en esta etapa. / 이 단계에서는 두 명 이상이 필요합니다. / Für diesen Bauschritt sind 2 oder mehr Personen erforderlich.



Do not tighten screws all the way for now. / Ne pas visser fermement pour l'instant. / No atornille con firmeza por ahora. / 아직 나사를 단단히 조이지 마십시오. / Bitte die Schrauben zum jetzigen Zeitpunkt noch nicht fest anziehen.

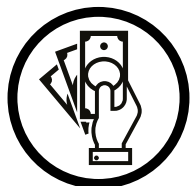

Sold separately. / Vendus séparément. / vendido en las opciones. / 옵션 판매 / Optional erhältlich

**B6** X4(+1)

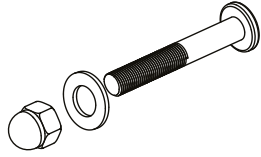

**Ha** X6(+1)

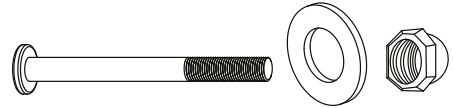

**Hb** X6(+1)

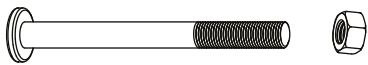

**Hc** X24(+4)

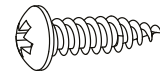

**Hd** X53(+5)

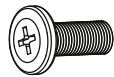

**He** X16(+3)

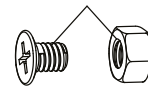

**Hf** X2(+1)

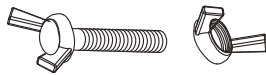

**Hg** X21(+3)

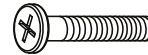

**Hh** X1

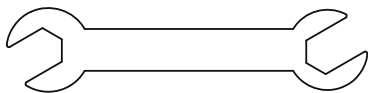

**Hi** X4(+1)

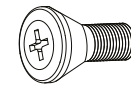

**Hk** X6(+1)

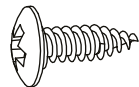

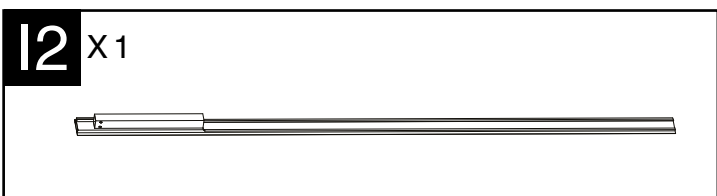
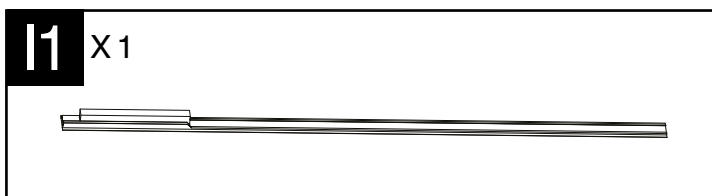
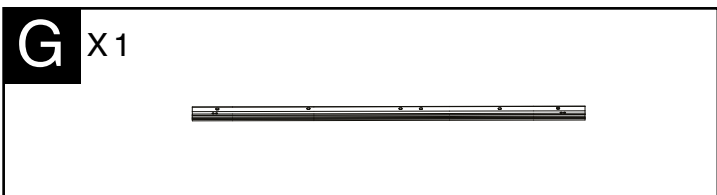
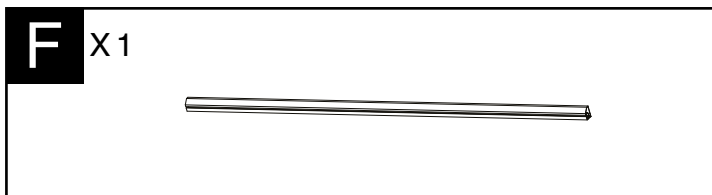
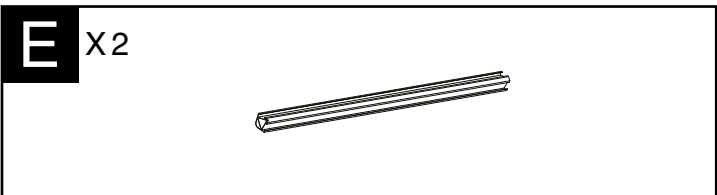
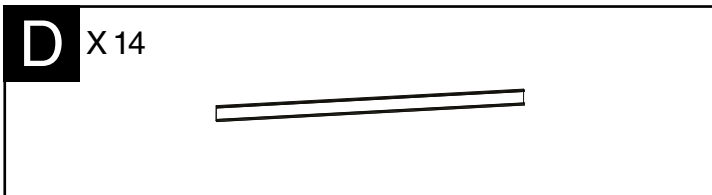
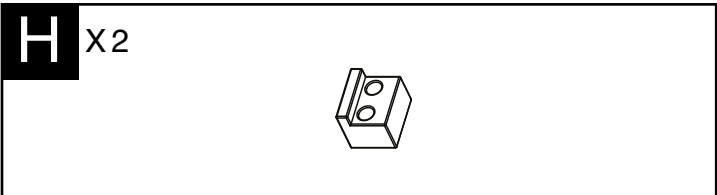
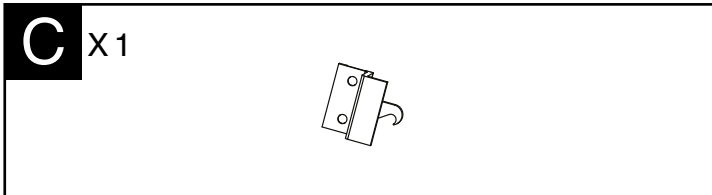
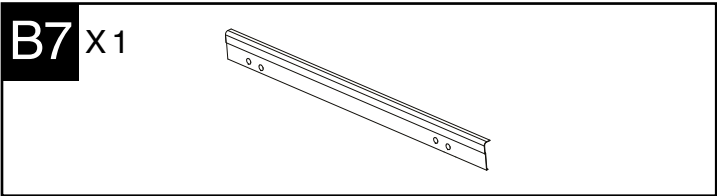
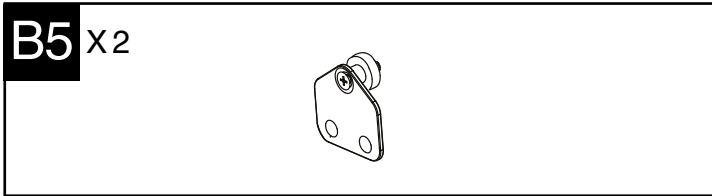
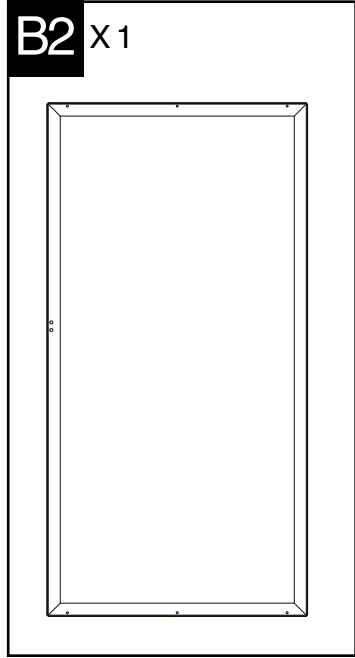
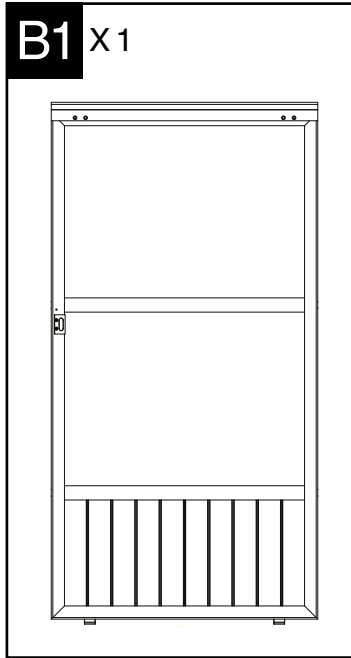
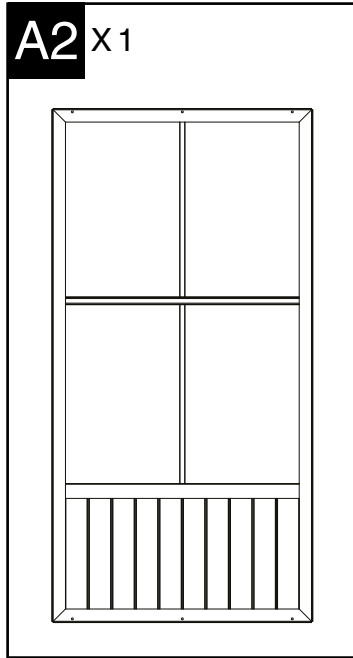
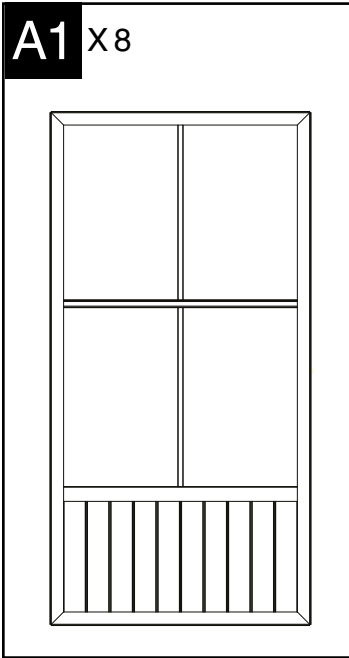

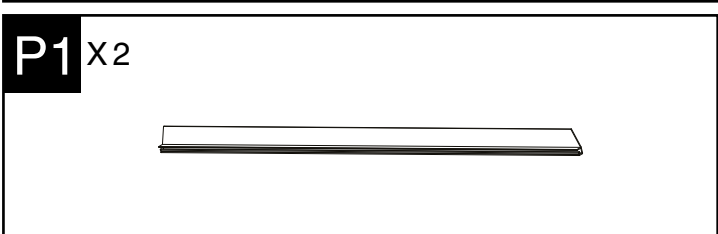
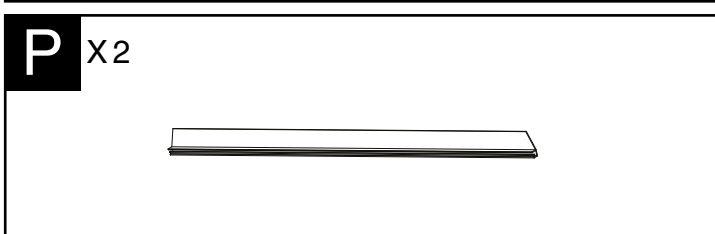
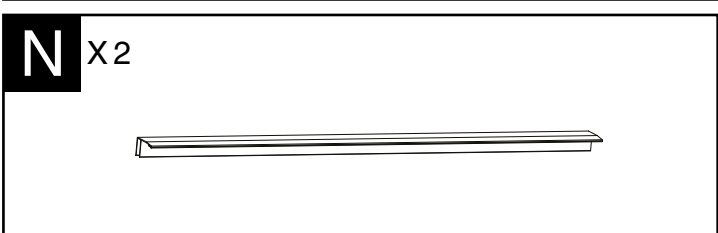
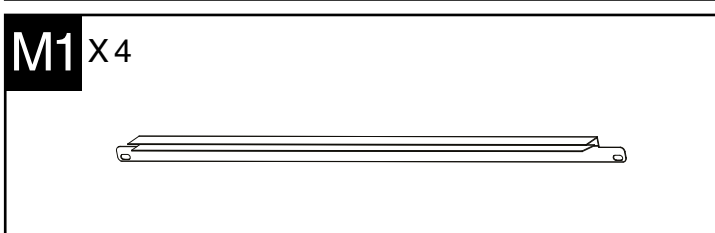
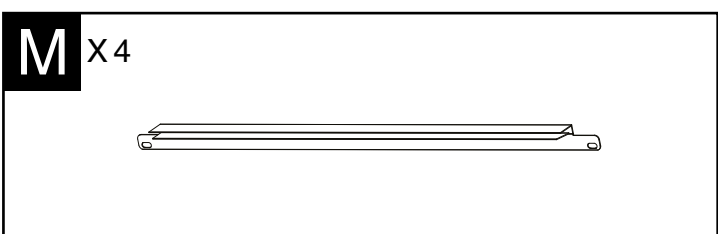
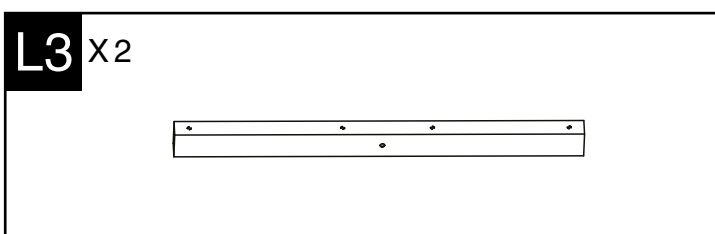
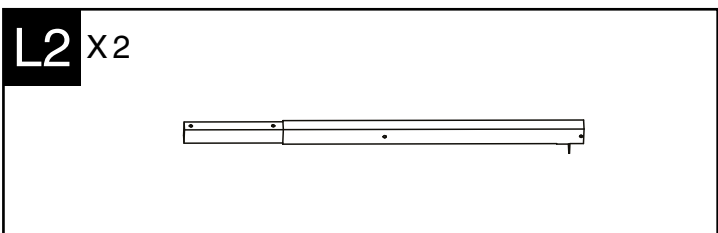
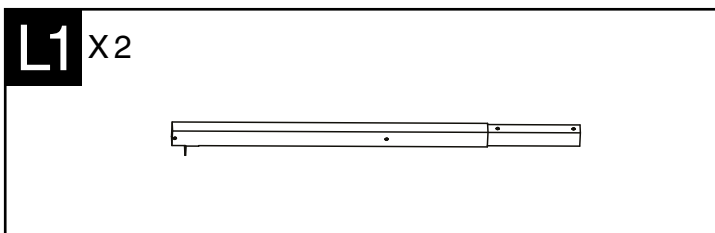
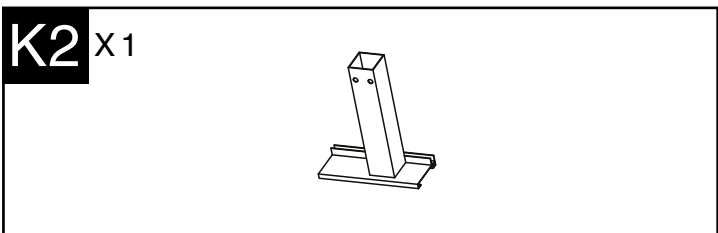
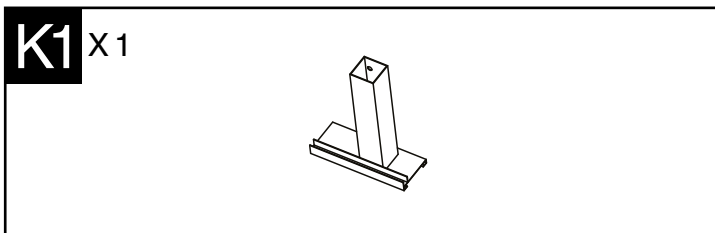
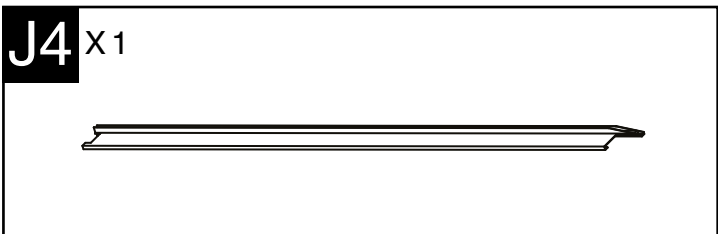
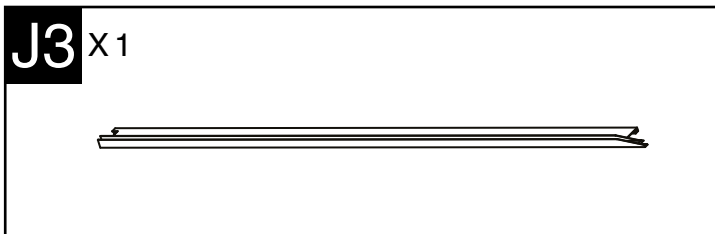
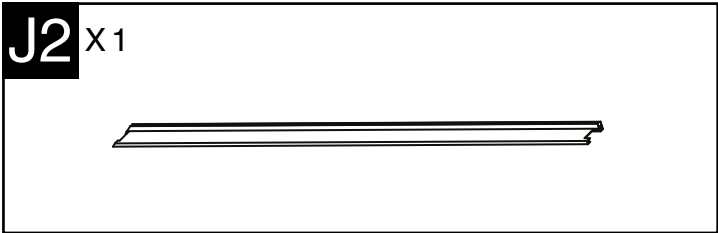
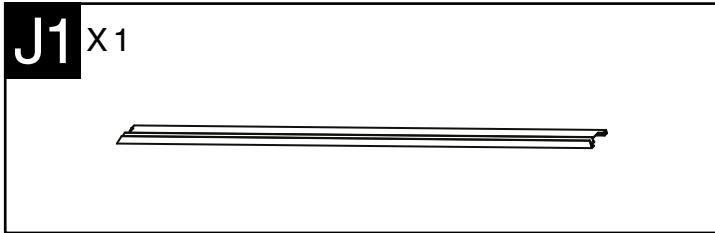

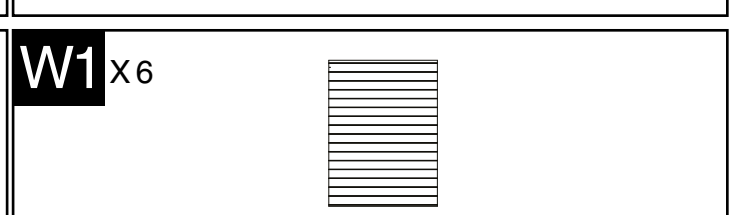
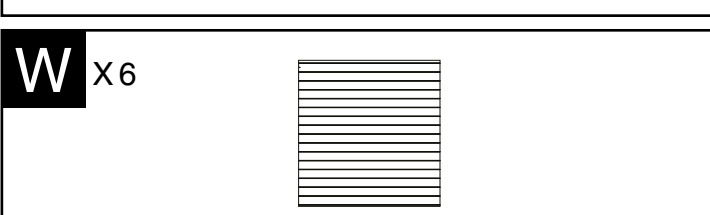
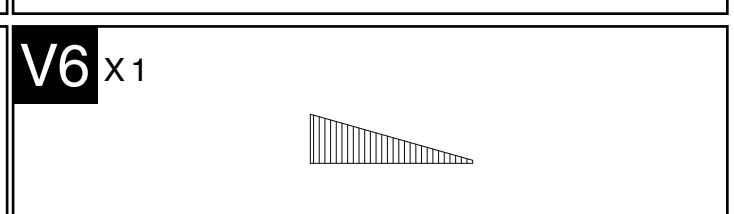
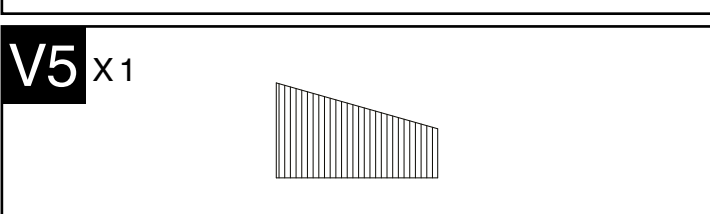
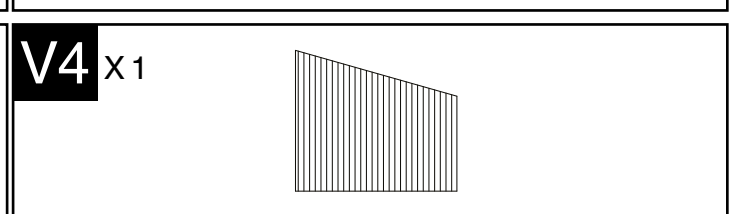
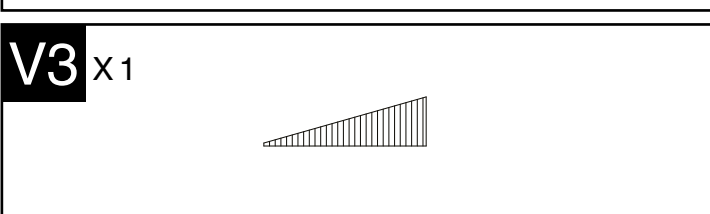
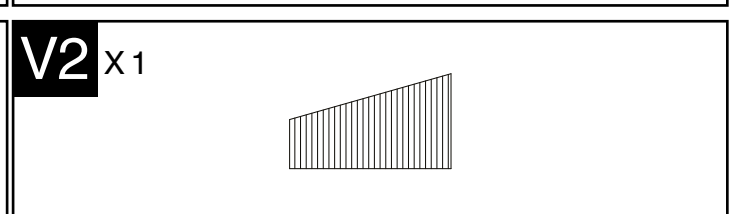
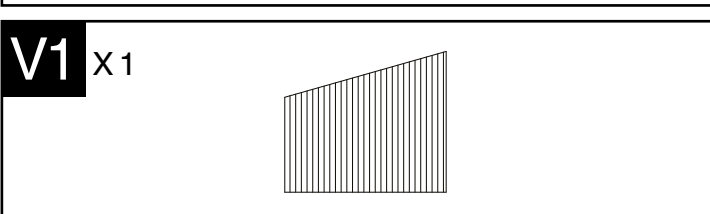
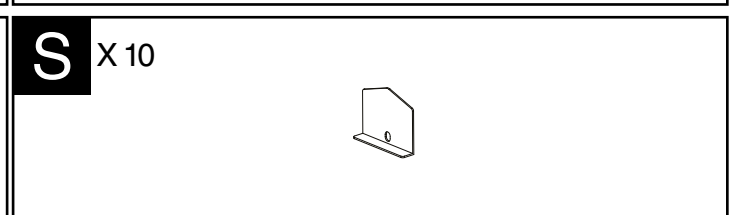
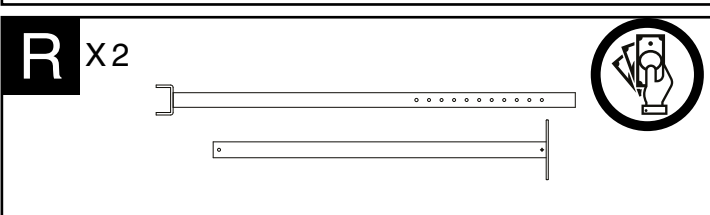
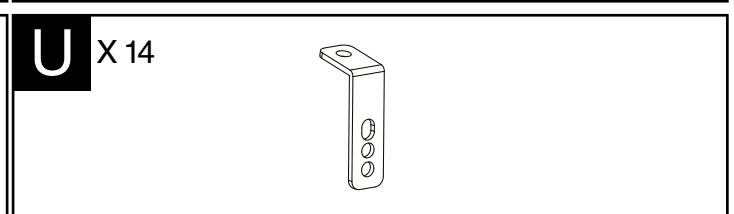
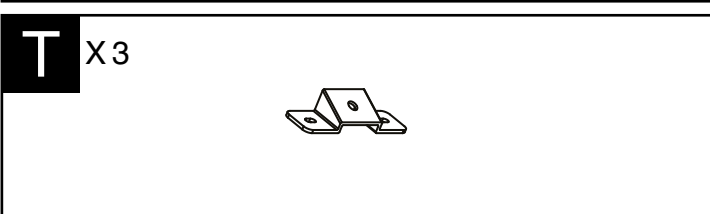
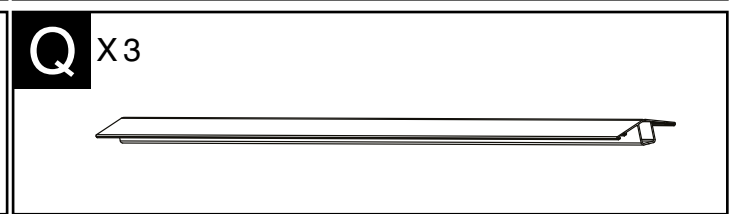
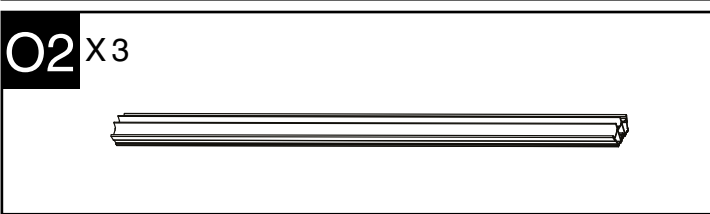
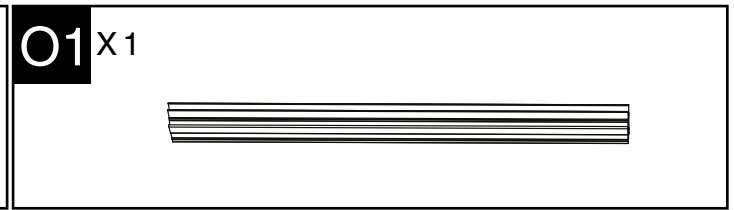
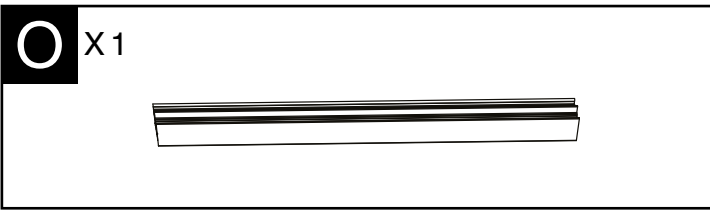

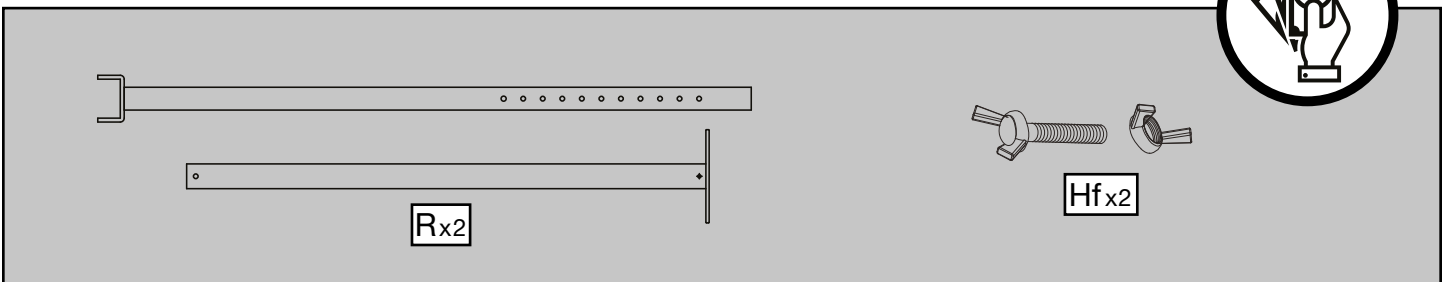
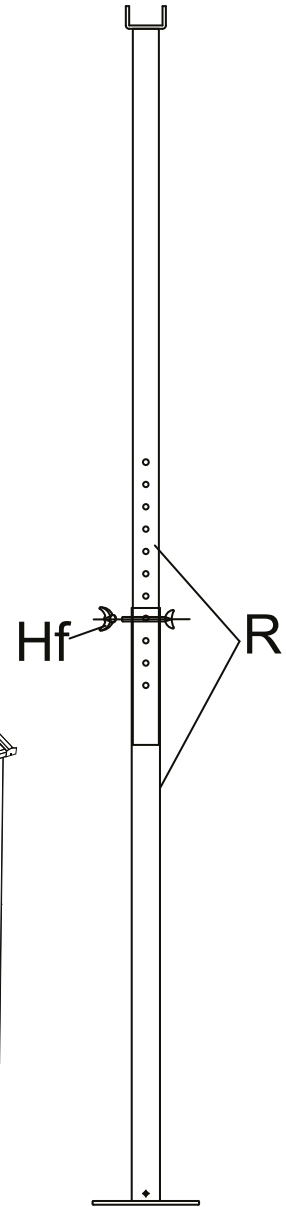
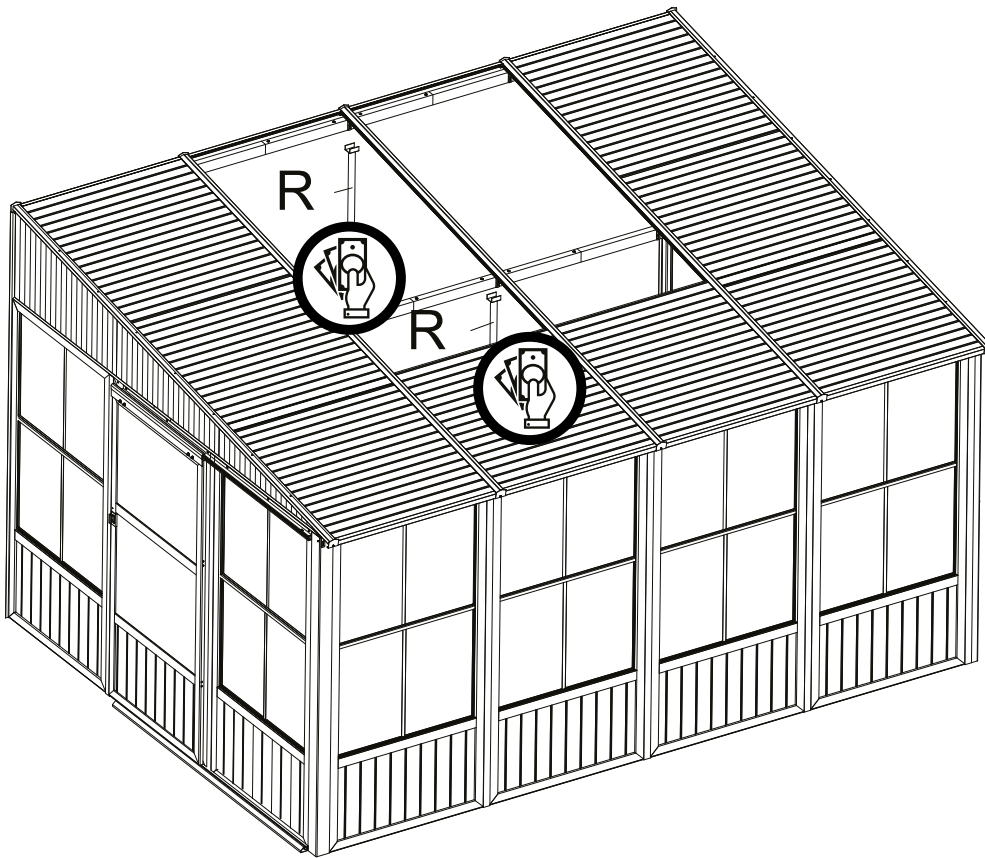
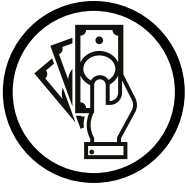

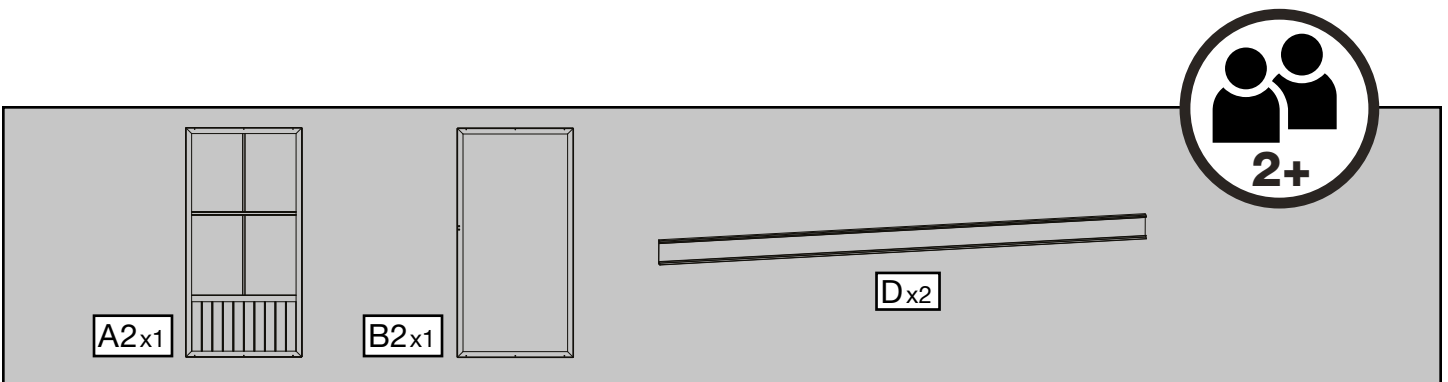
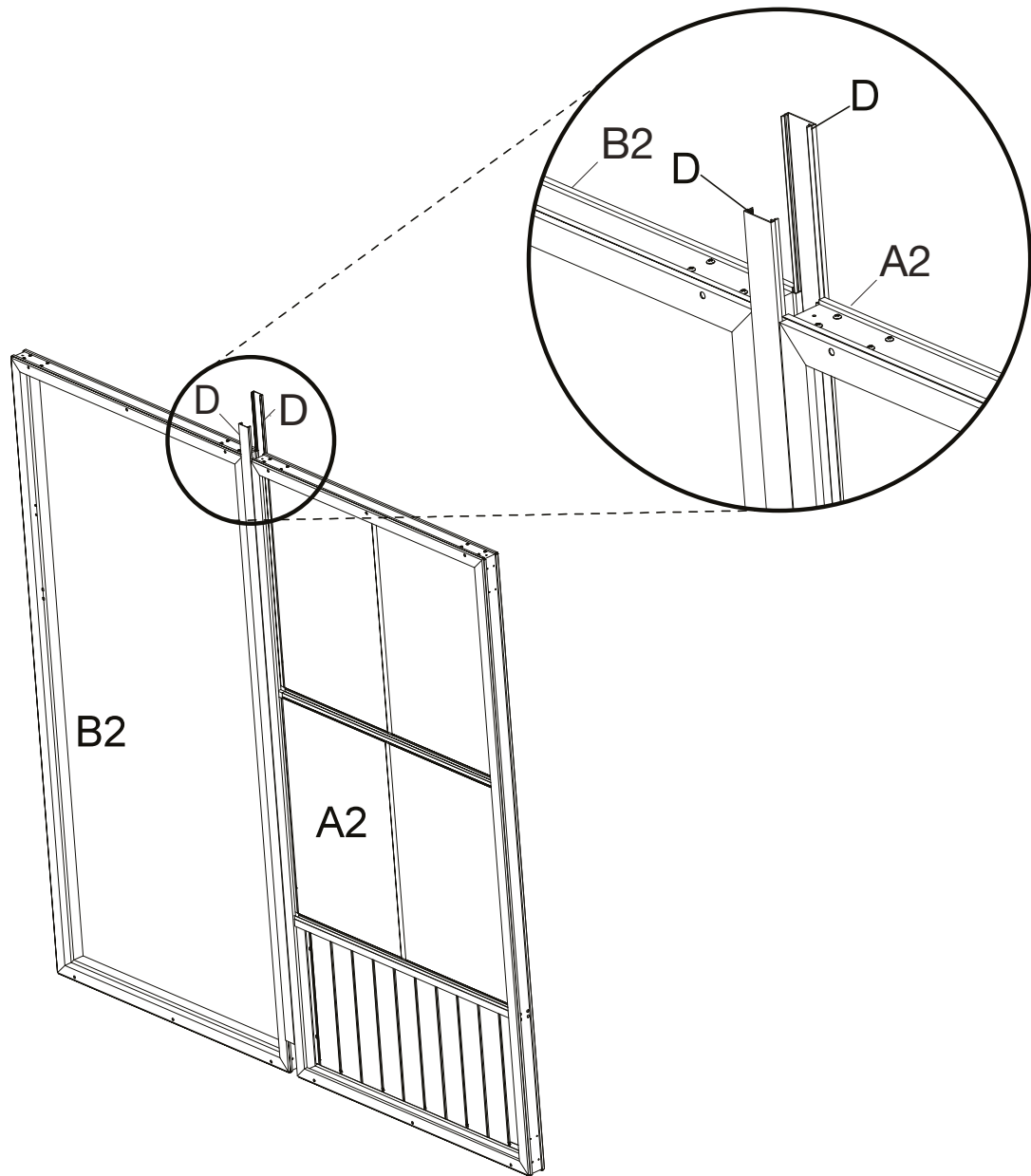



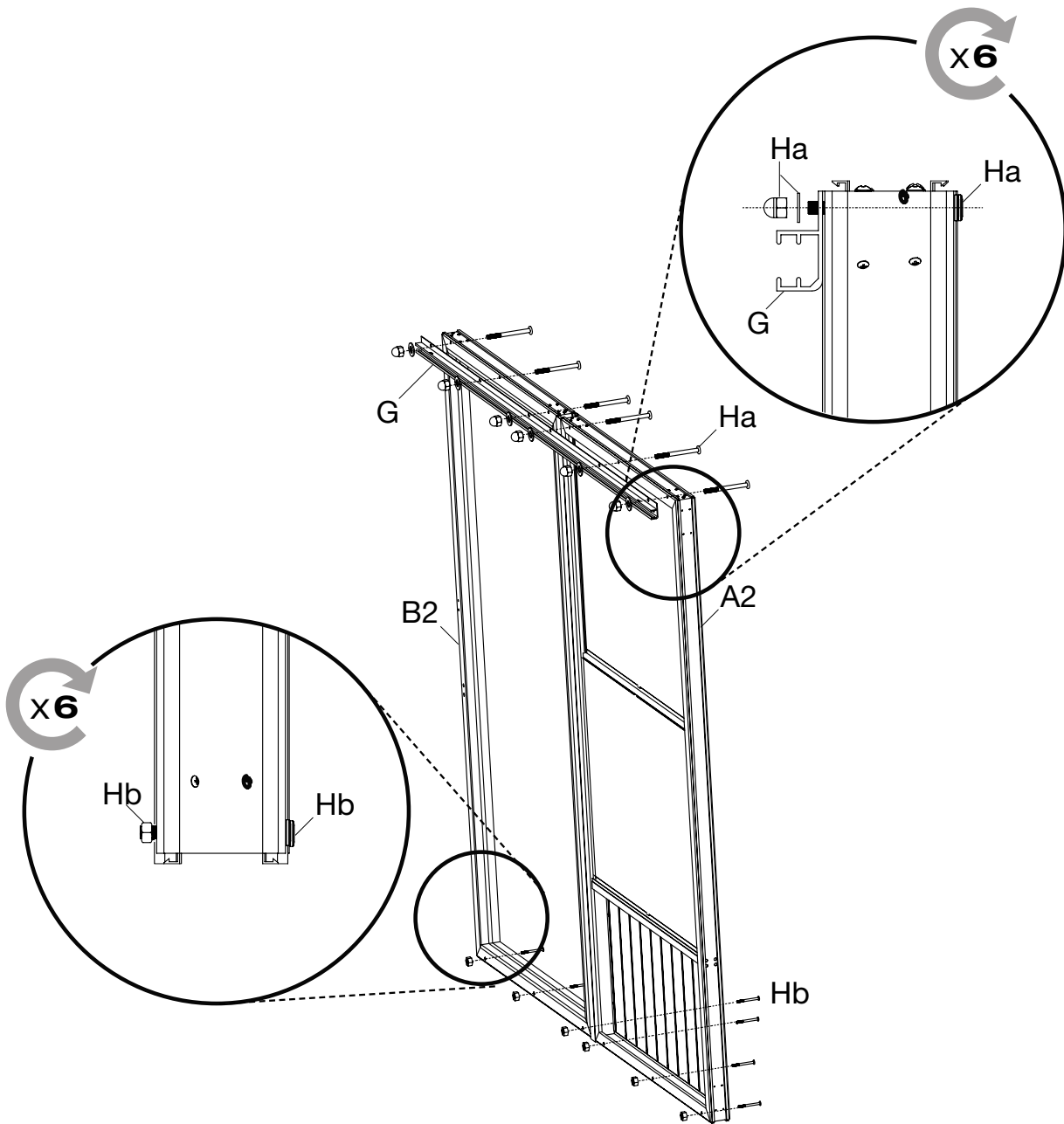

This section contains the parts list and safety instructions for the assembly step. The parts list includes:

- Gx1: A long horizontal rail.
- Hbx6: A bolt with a washer and nut.
- Hax6: A bolt with a washer and nut.

The safety icons include:

- A '2+' icon, indicating that at least two people are required for this step.
- A 'no force' icon, indicating that excessive force should not be used during assembly.

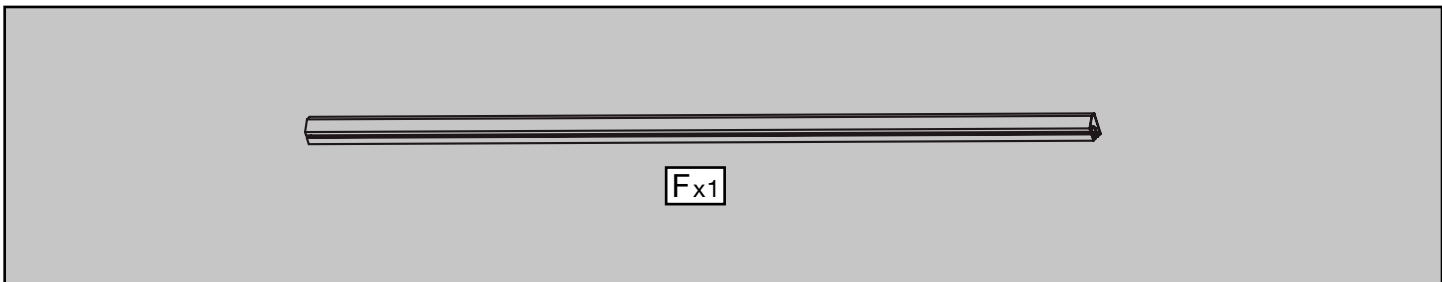
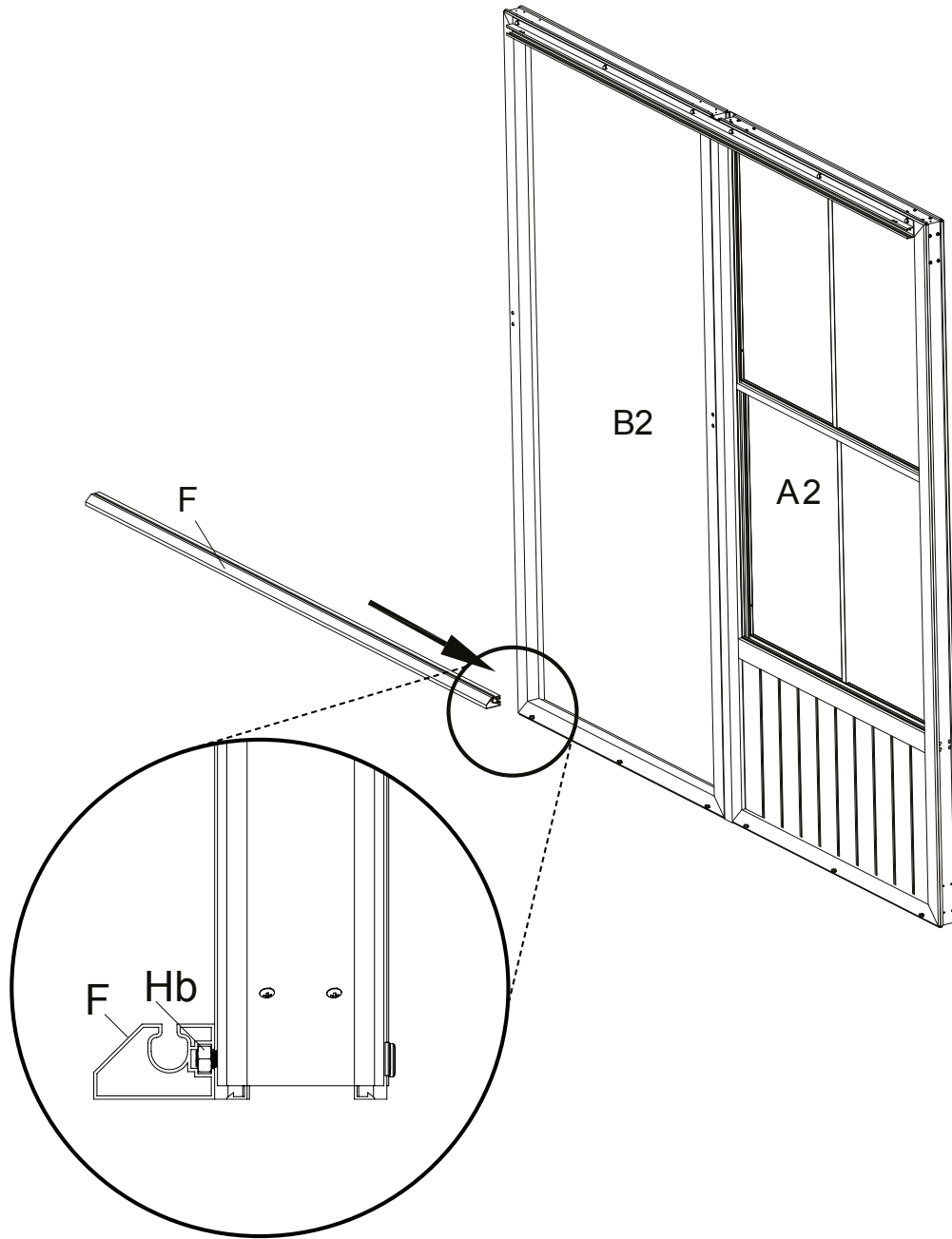

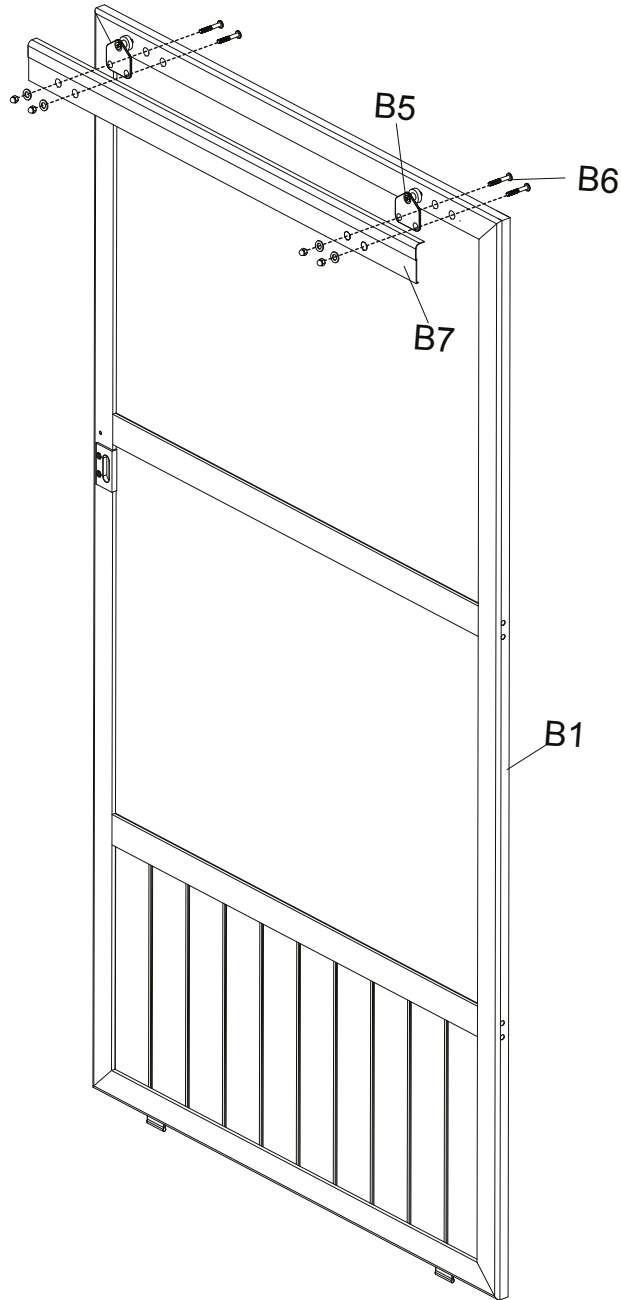

B1x1



B5x2

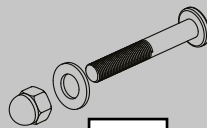

B6x4

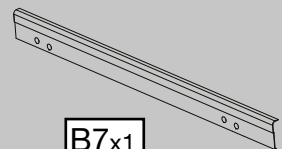

B7x1

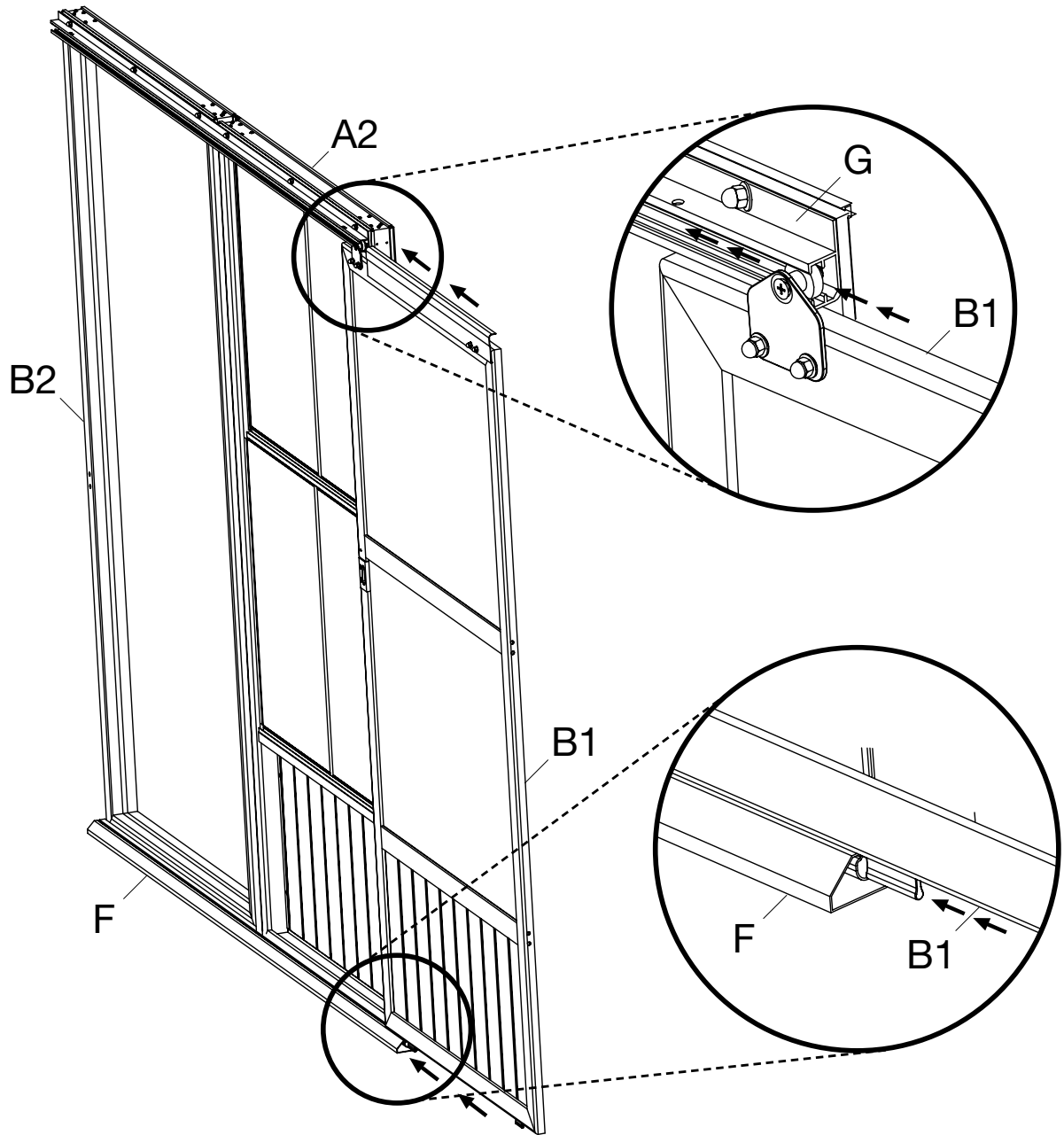

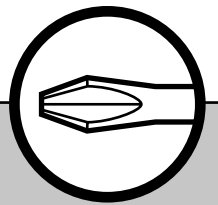
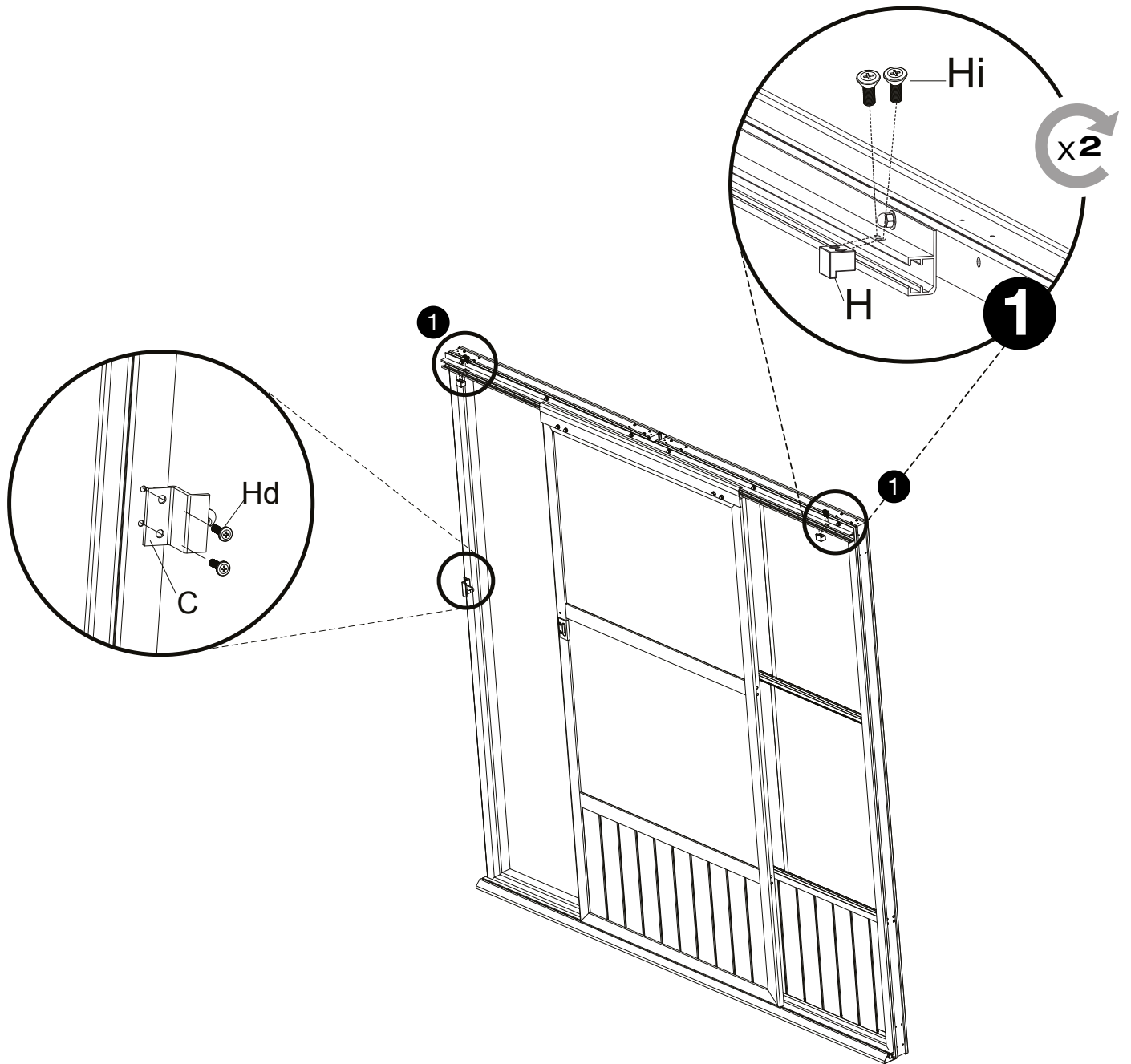

Hx2

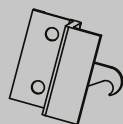

Cx1

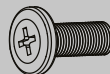

Hdx2

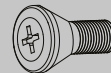

Hix4

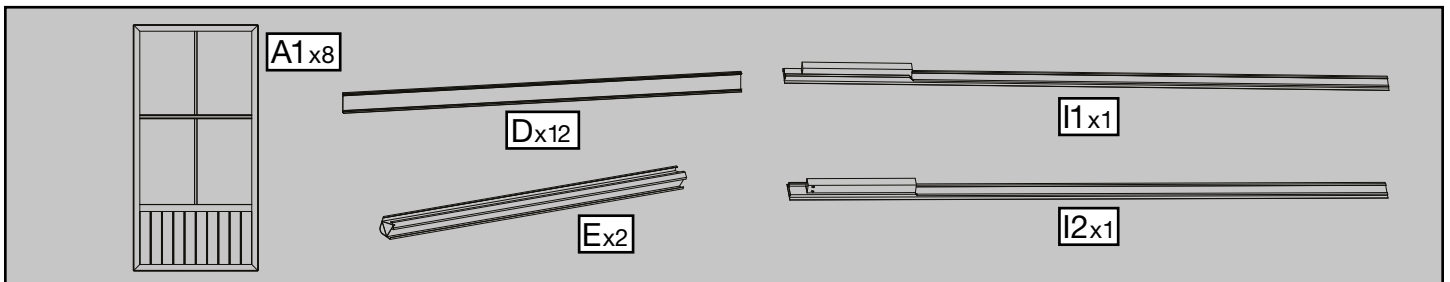
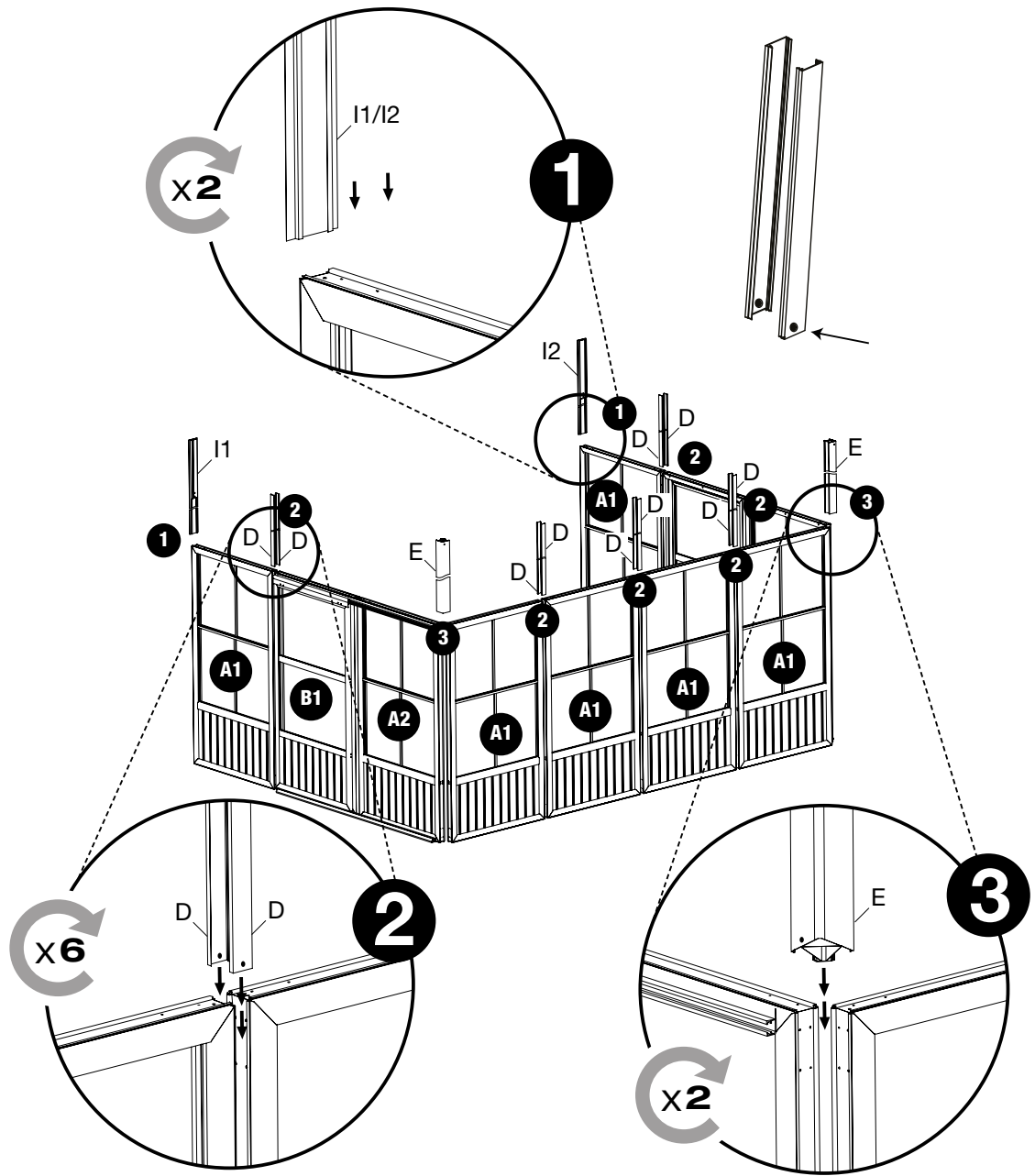

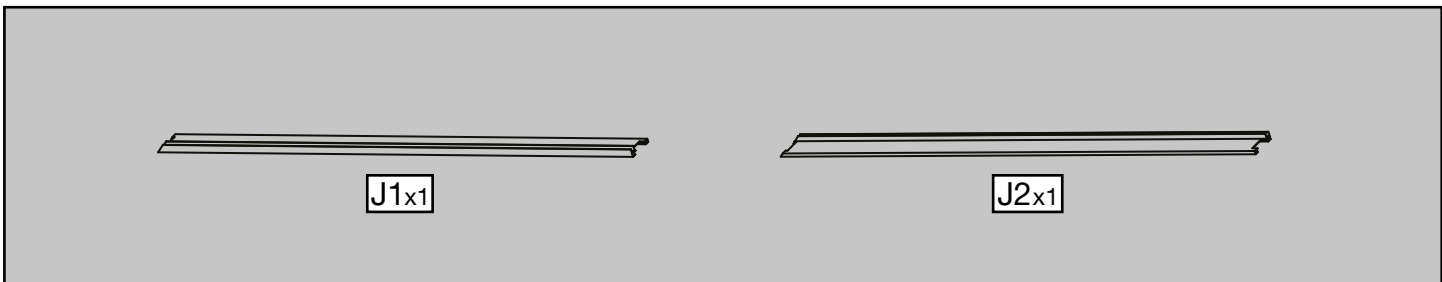
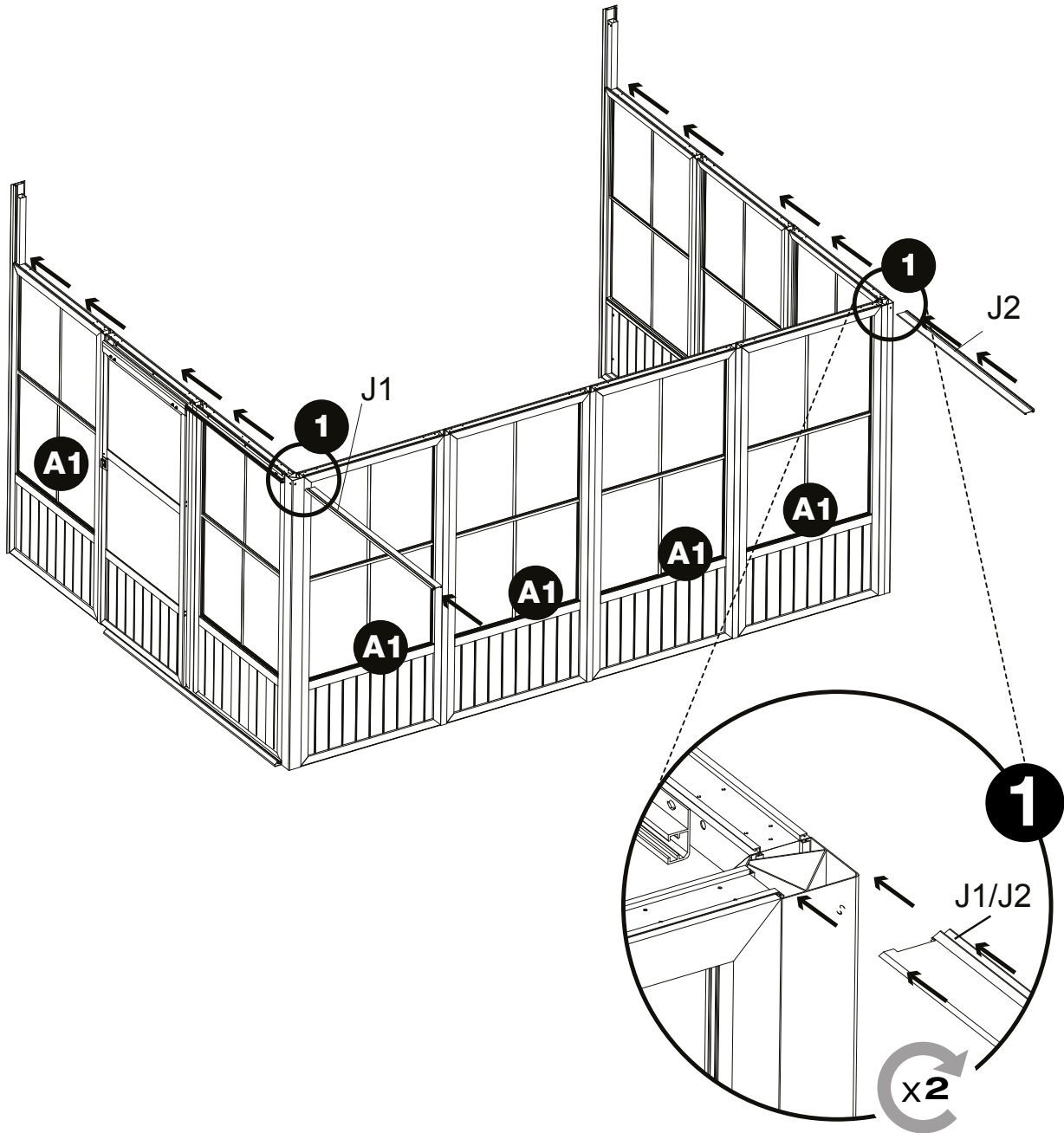

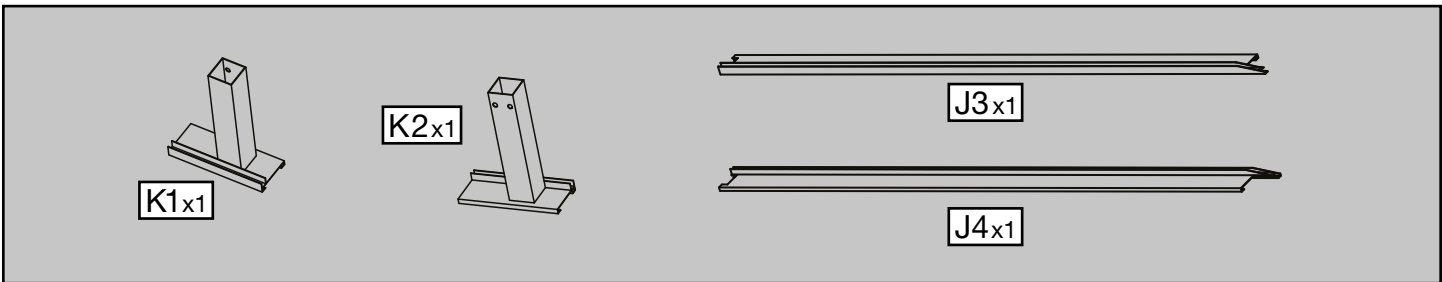
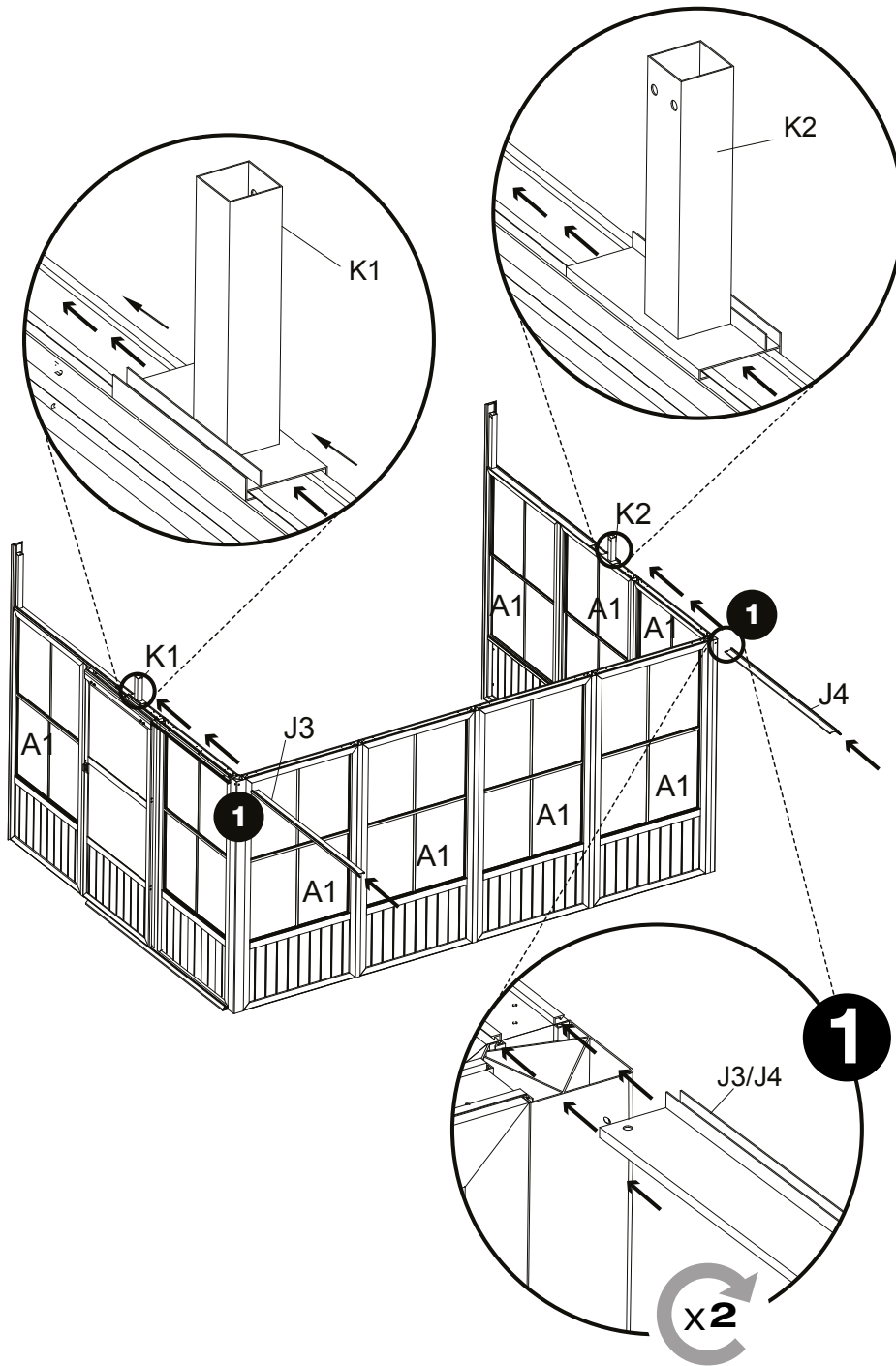



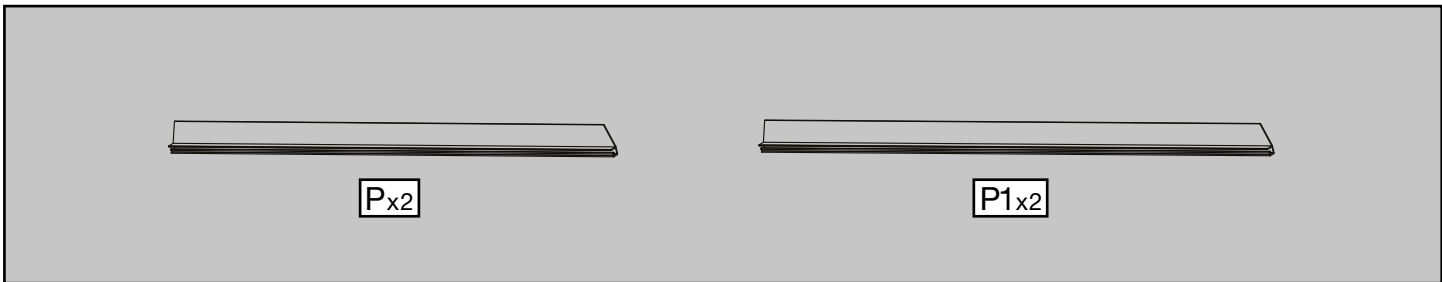
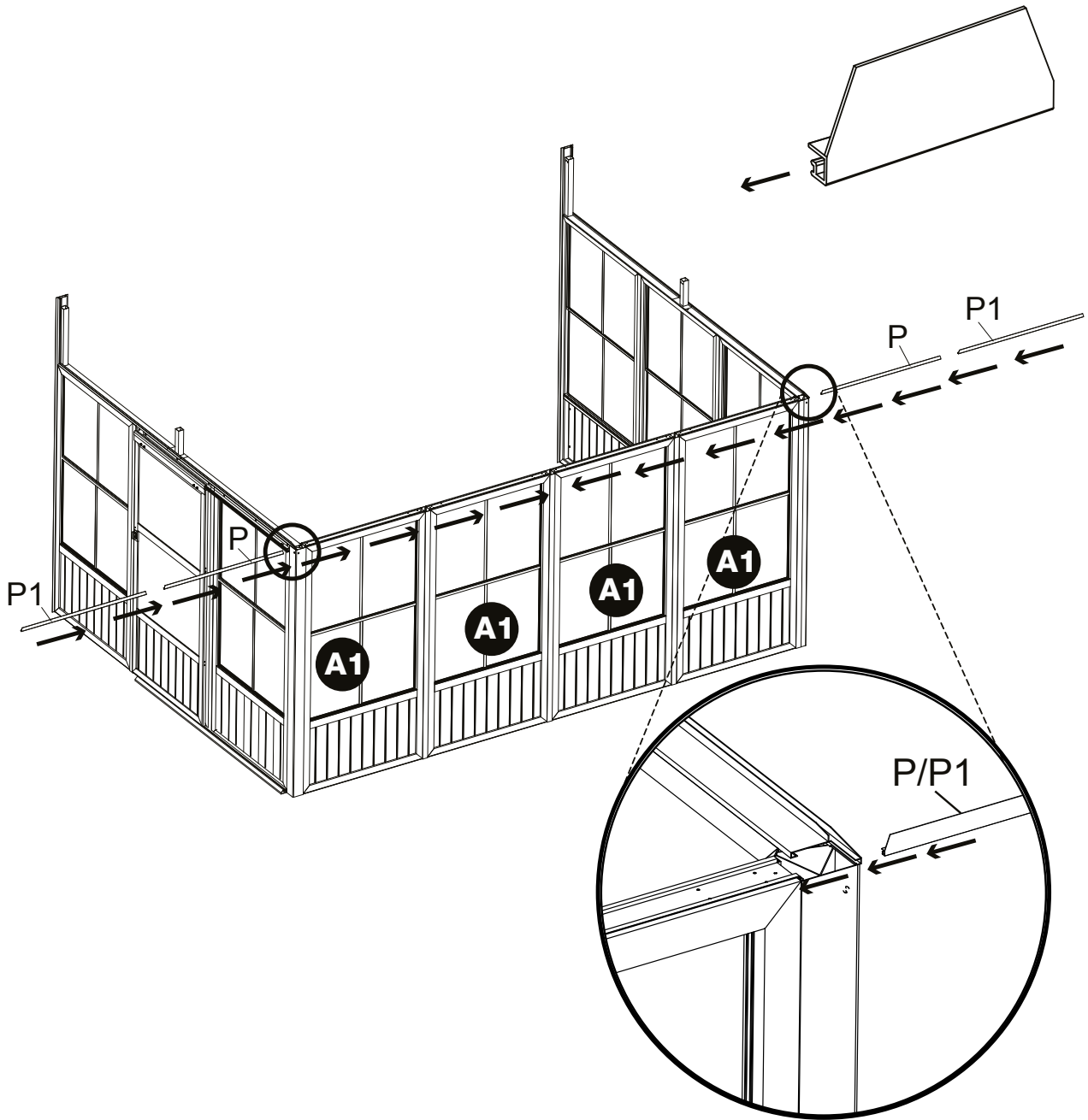

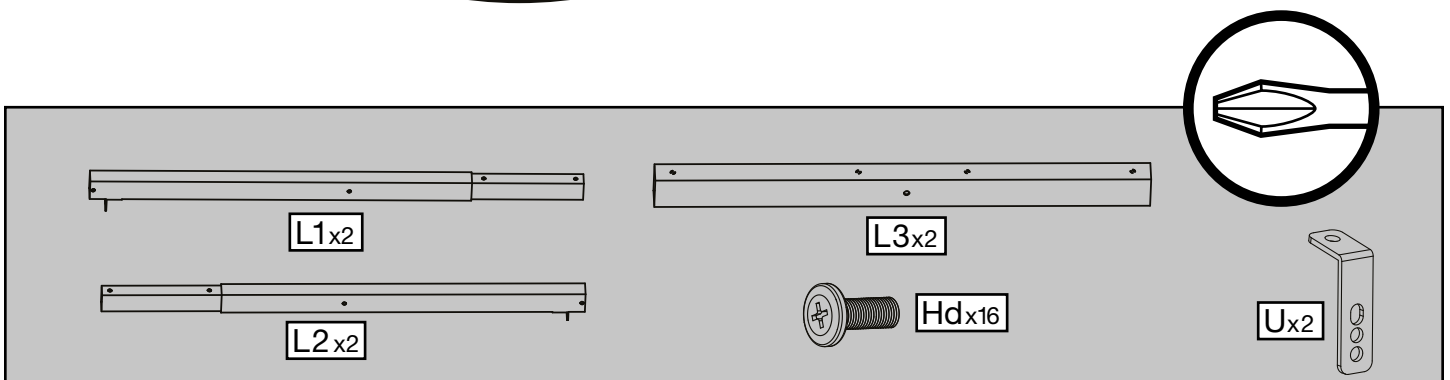
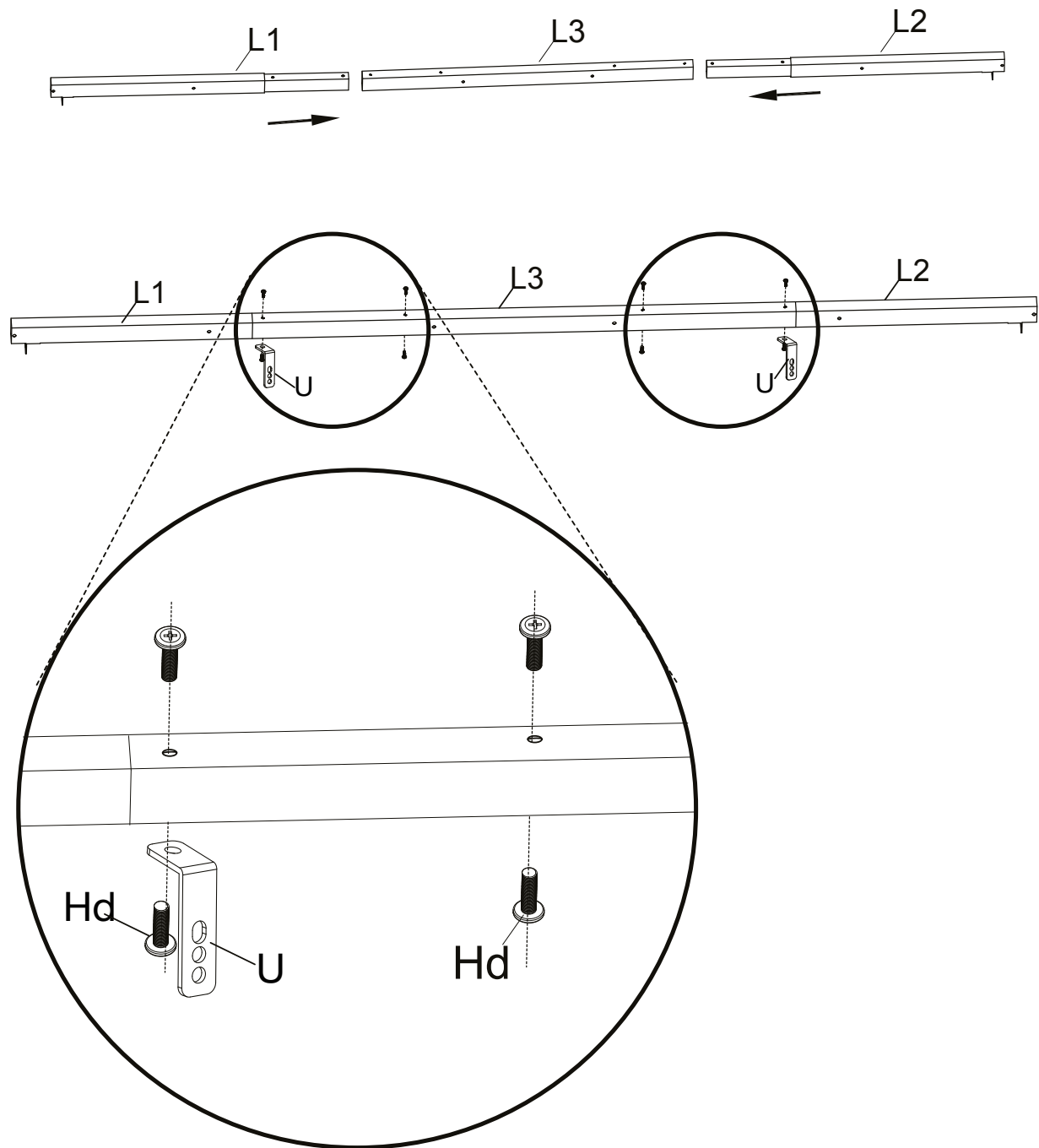

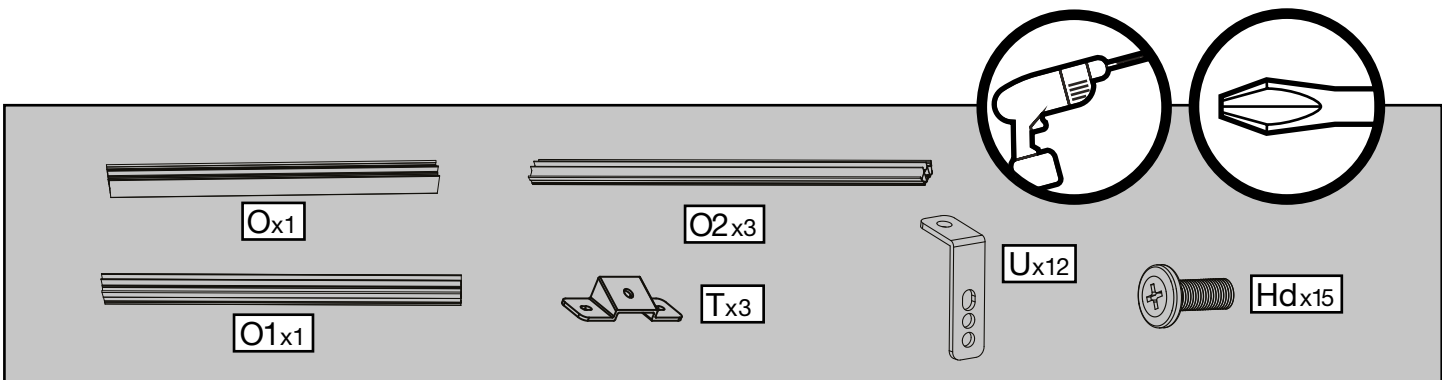
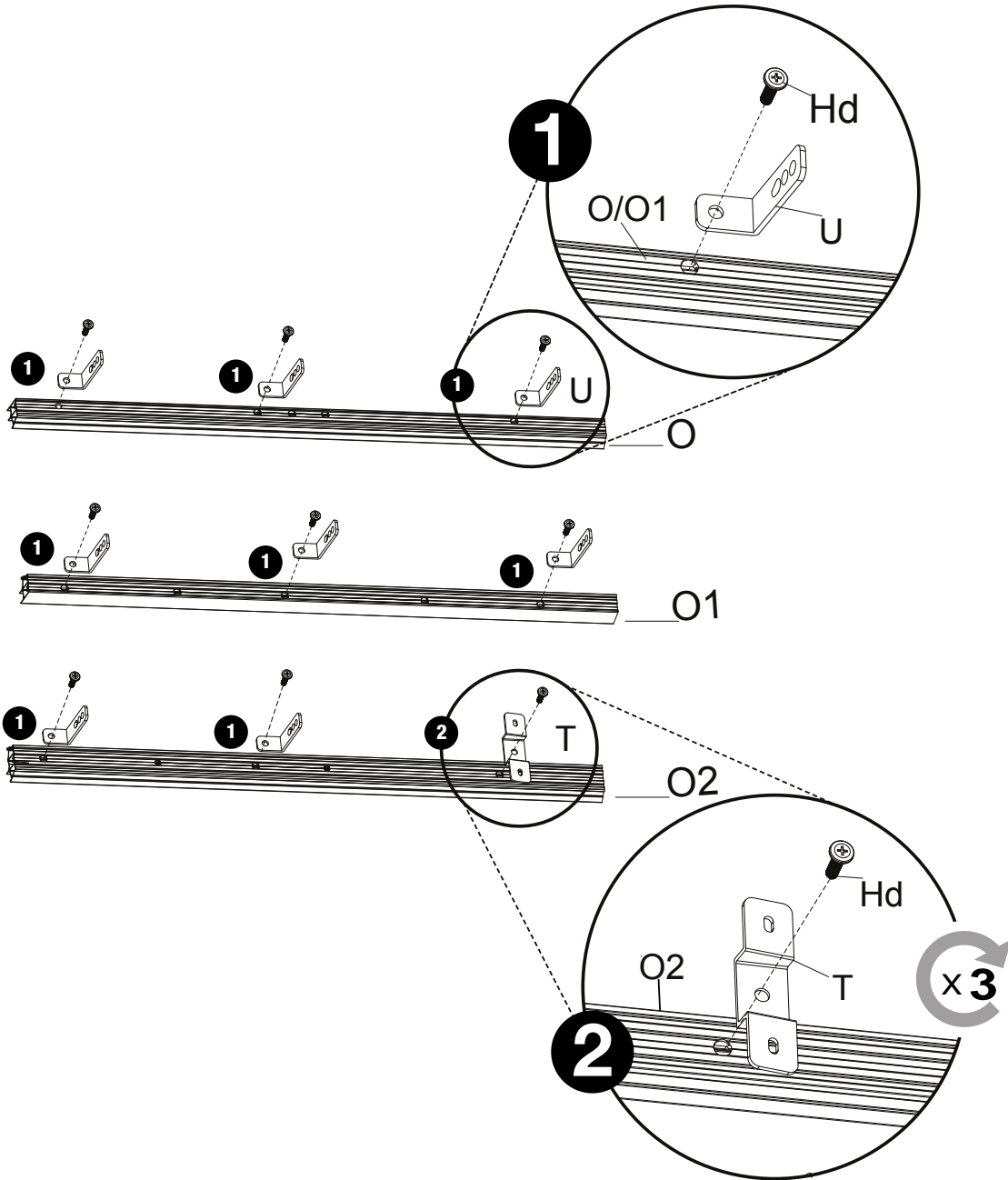

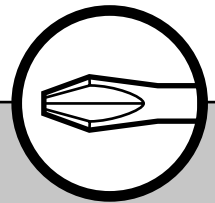
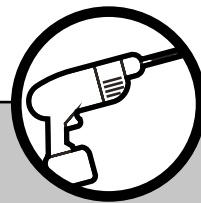
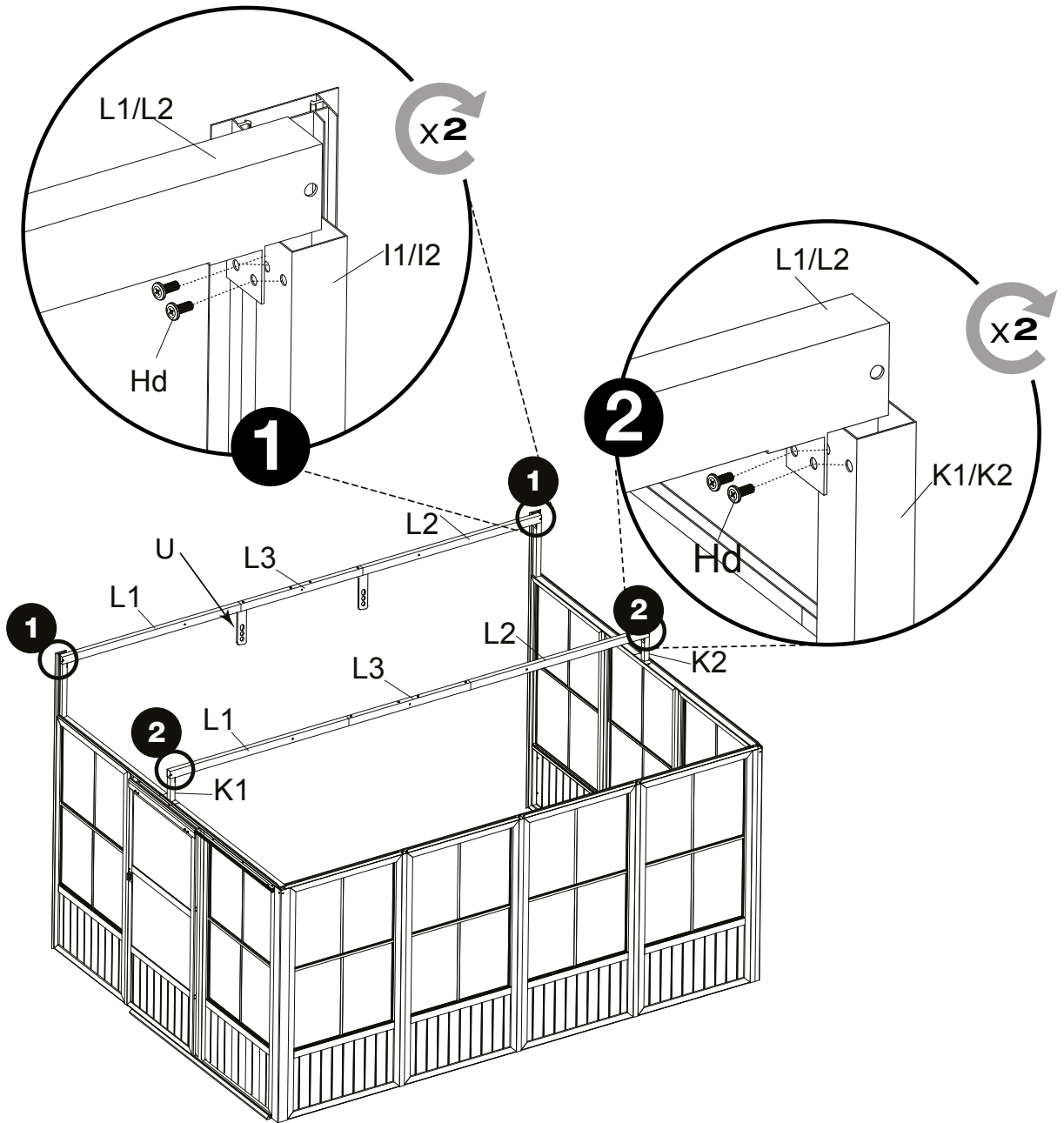

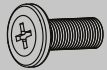
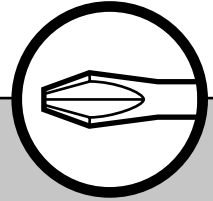
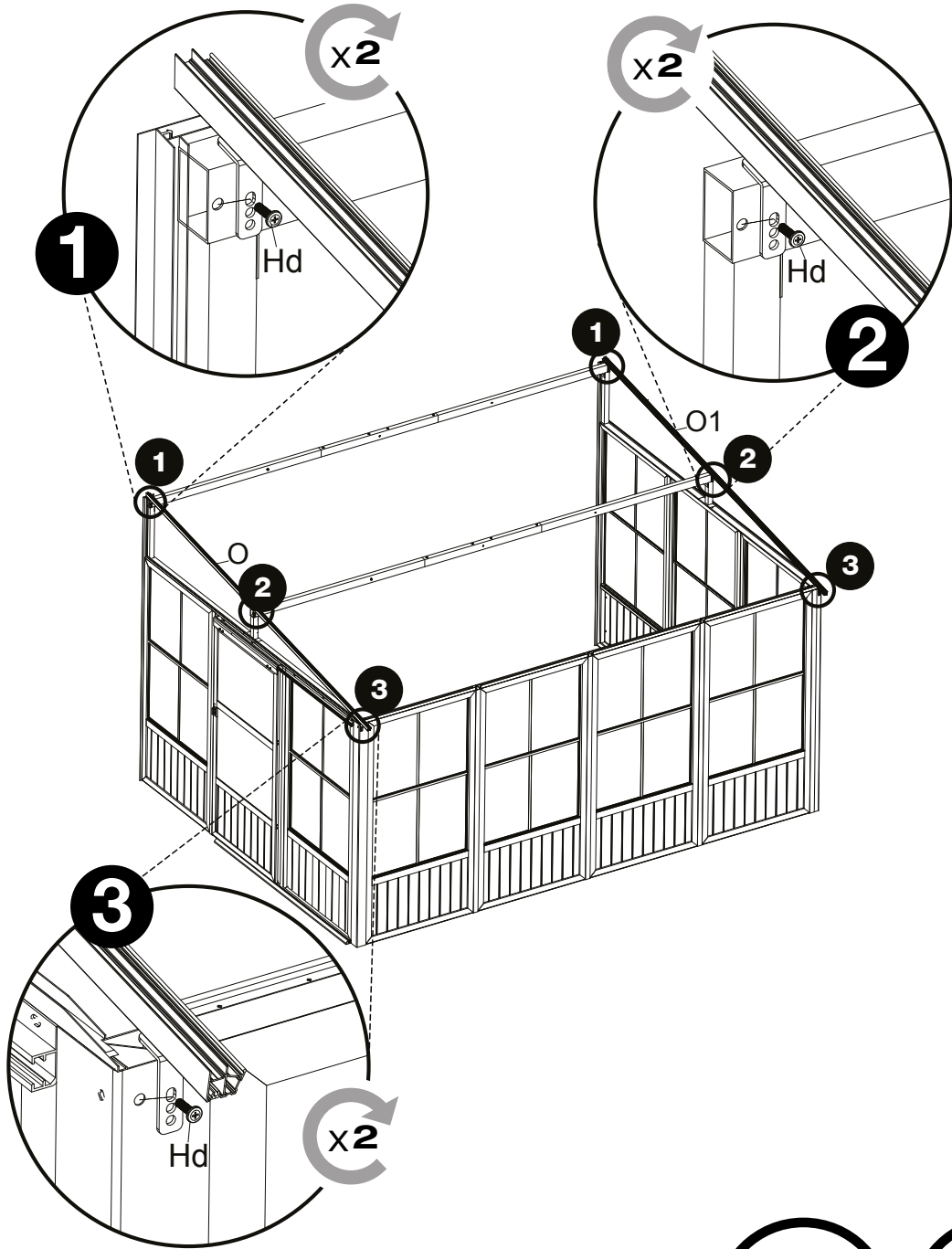

Hd x6

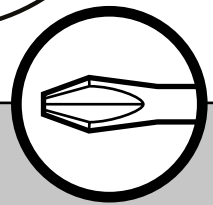
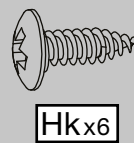
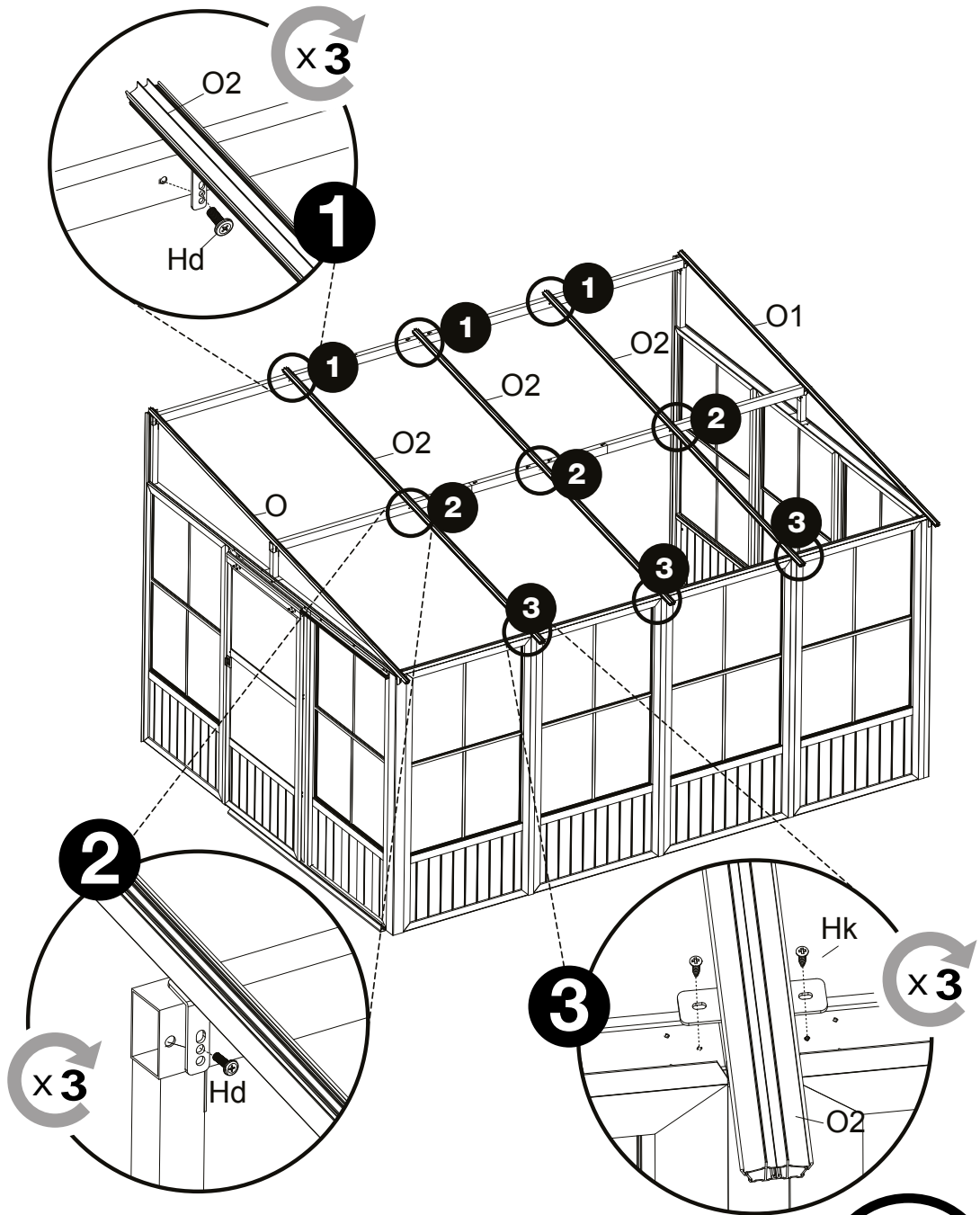

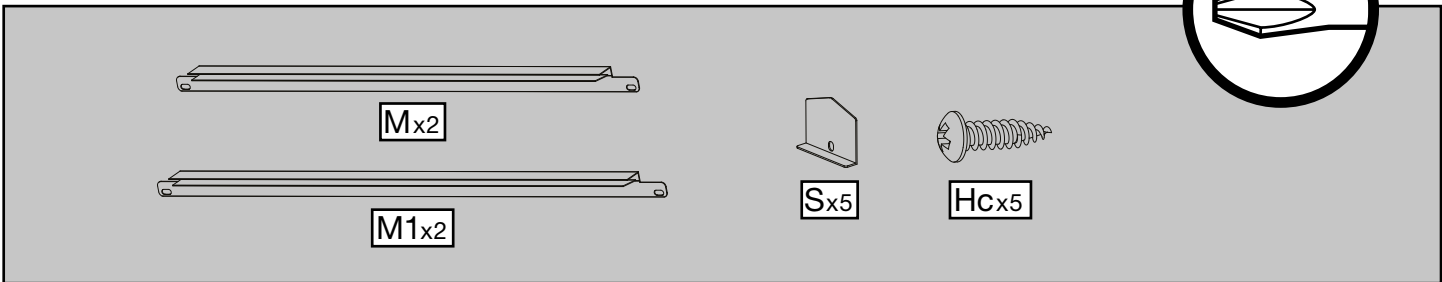
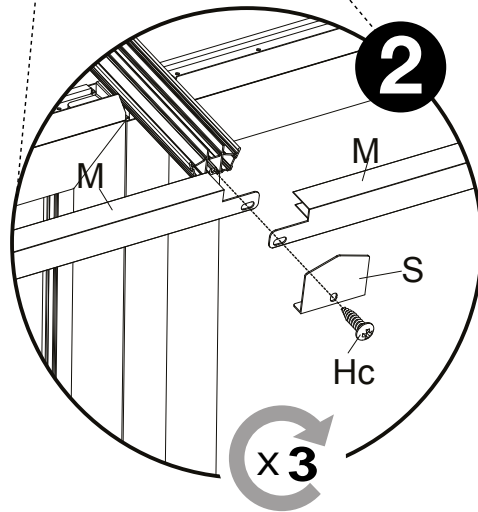
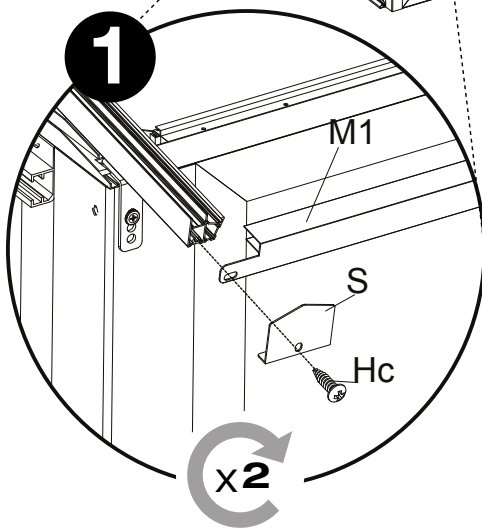
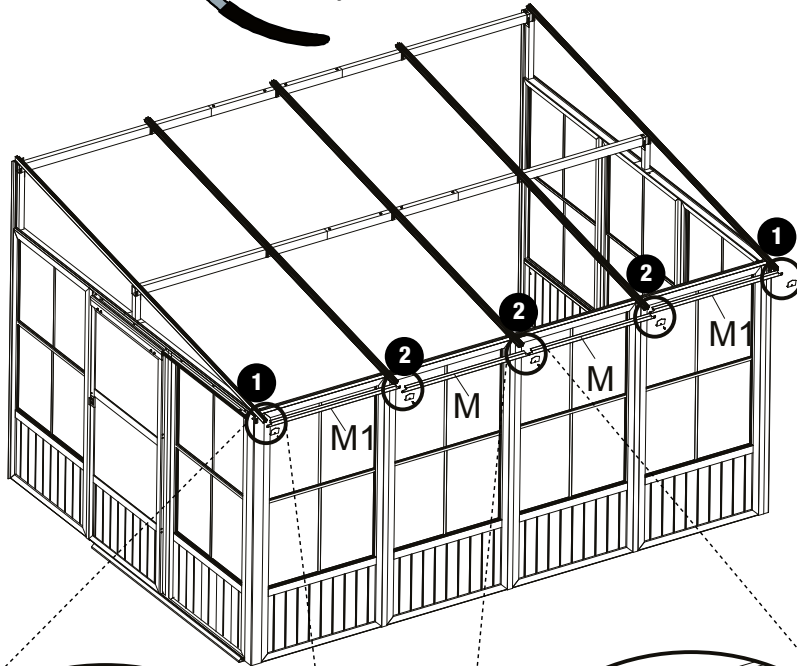
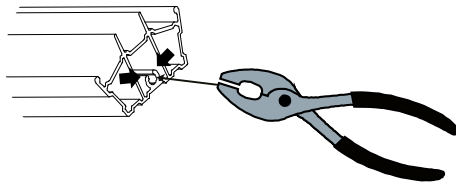

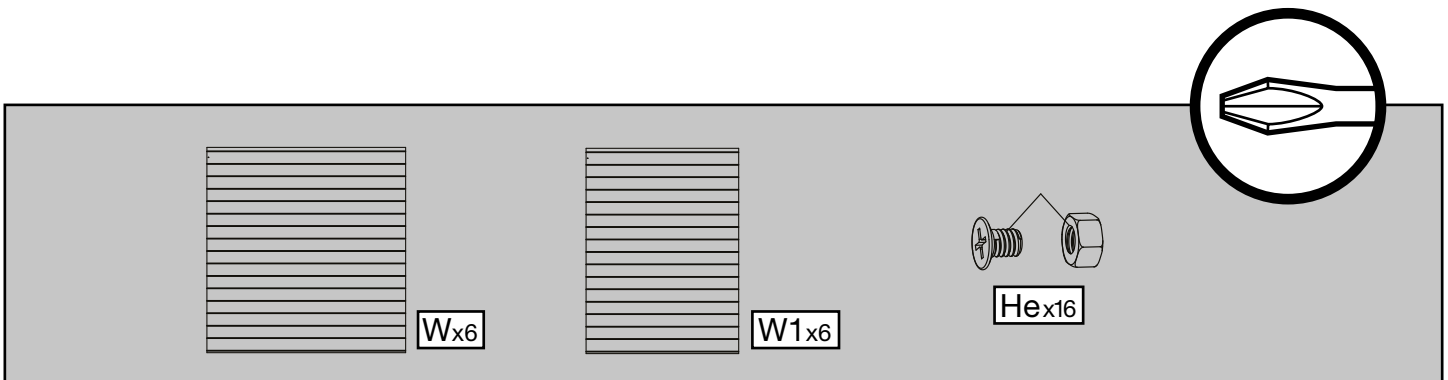
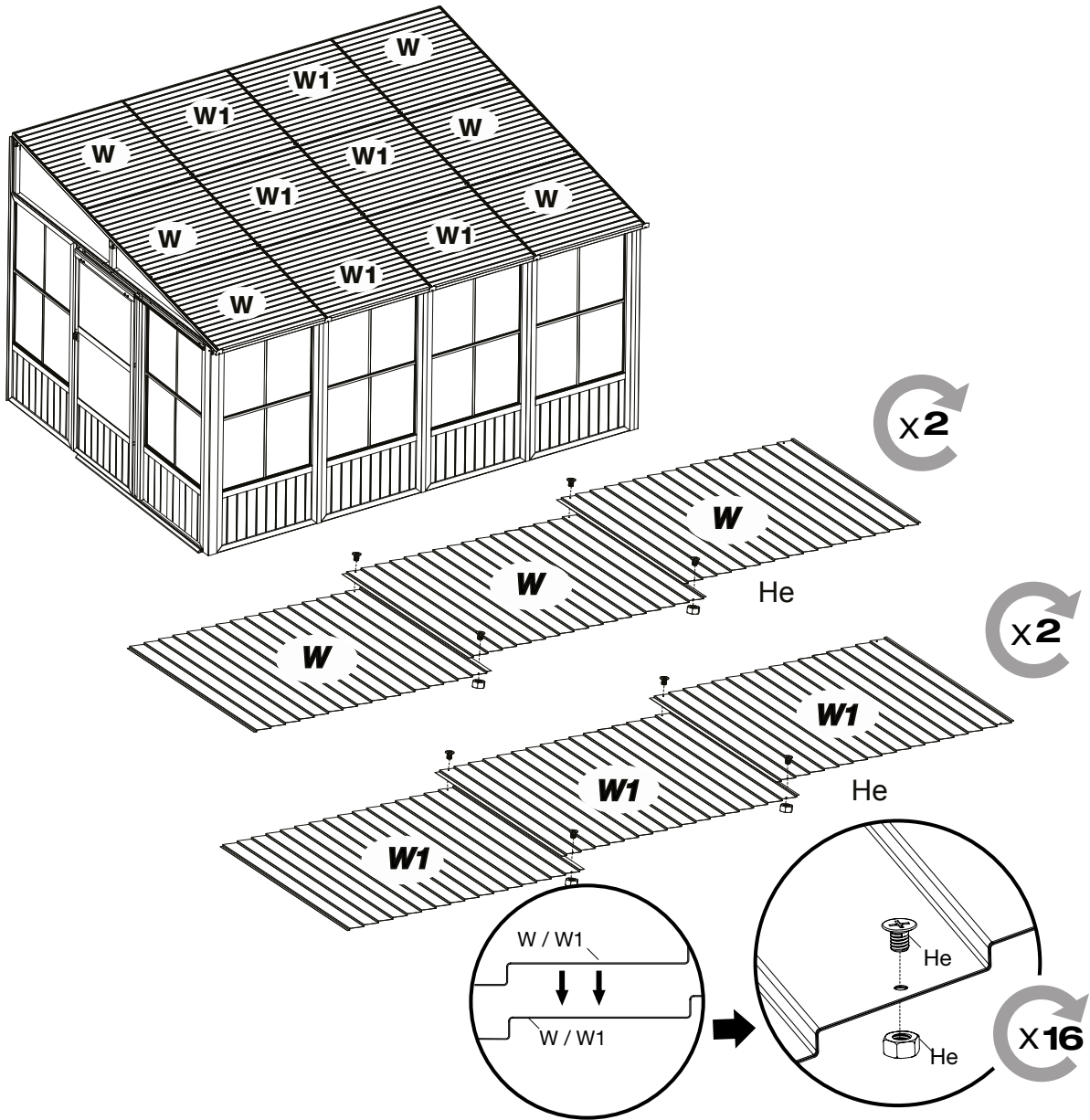



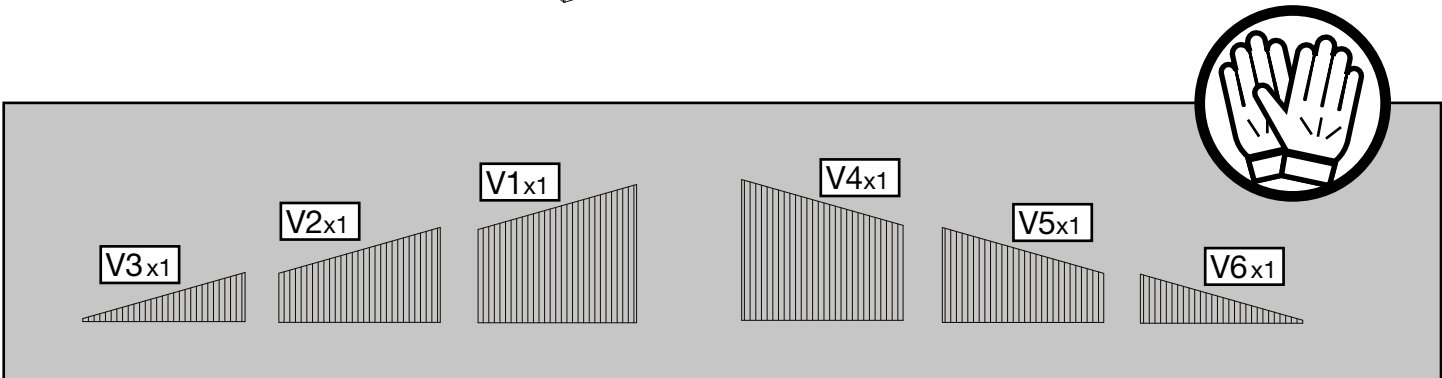
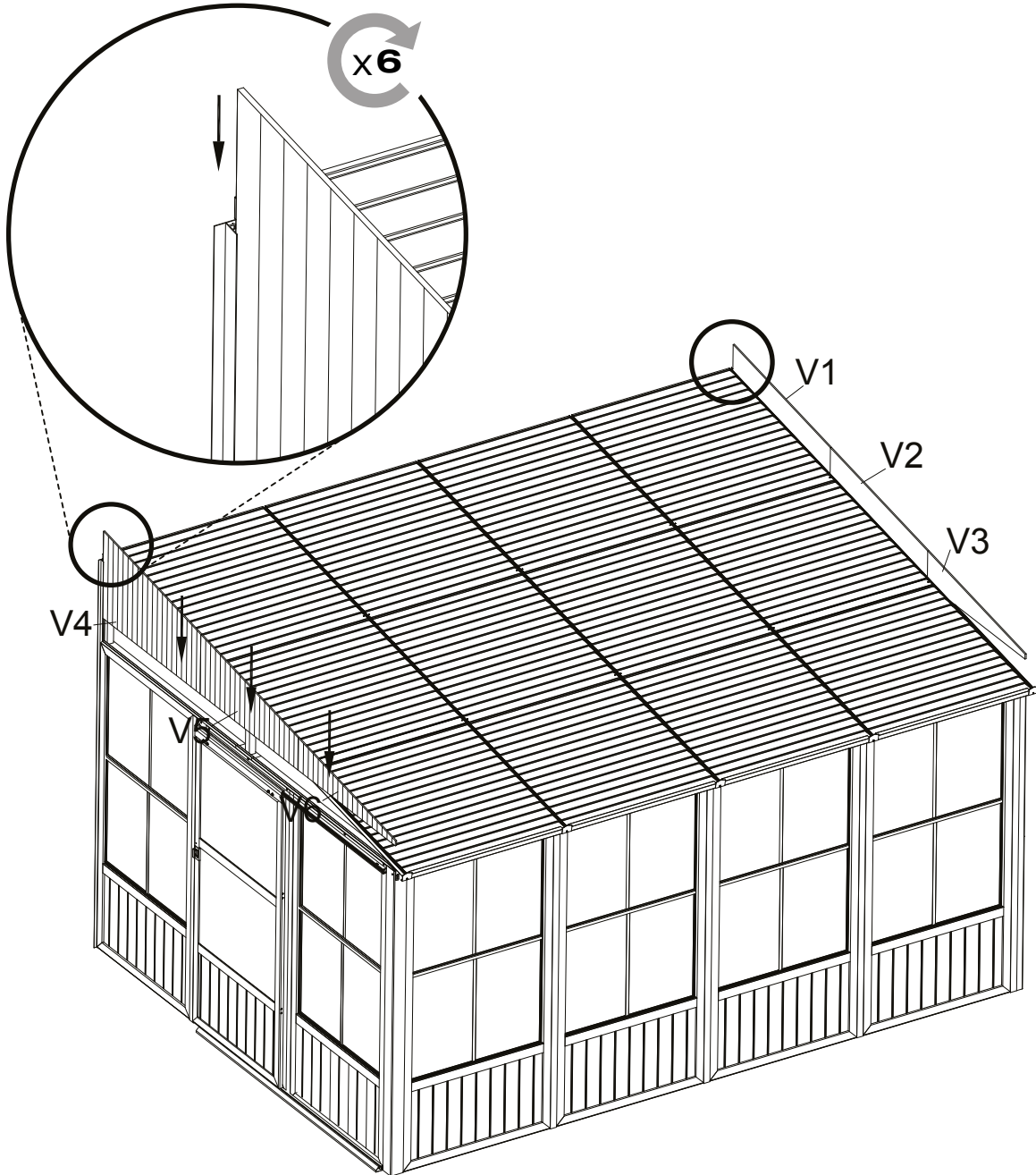

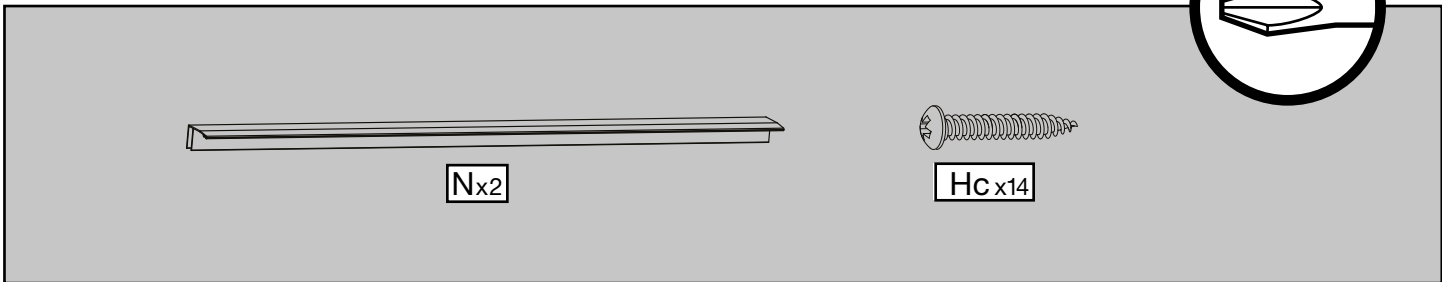
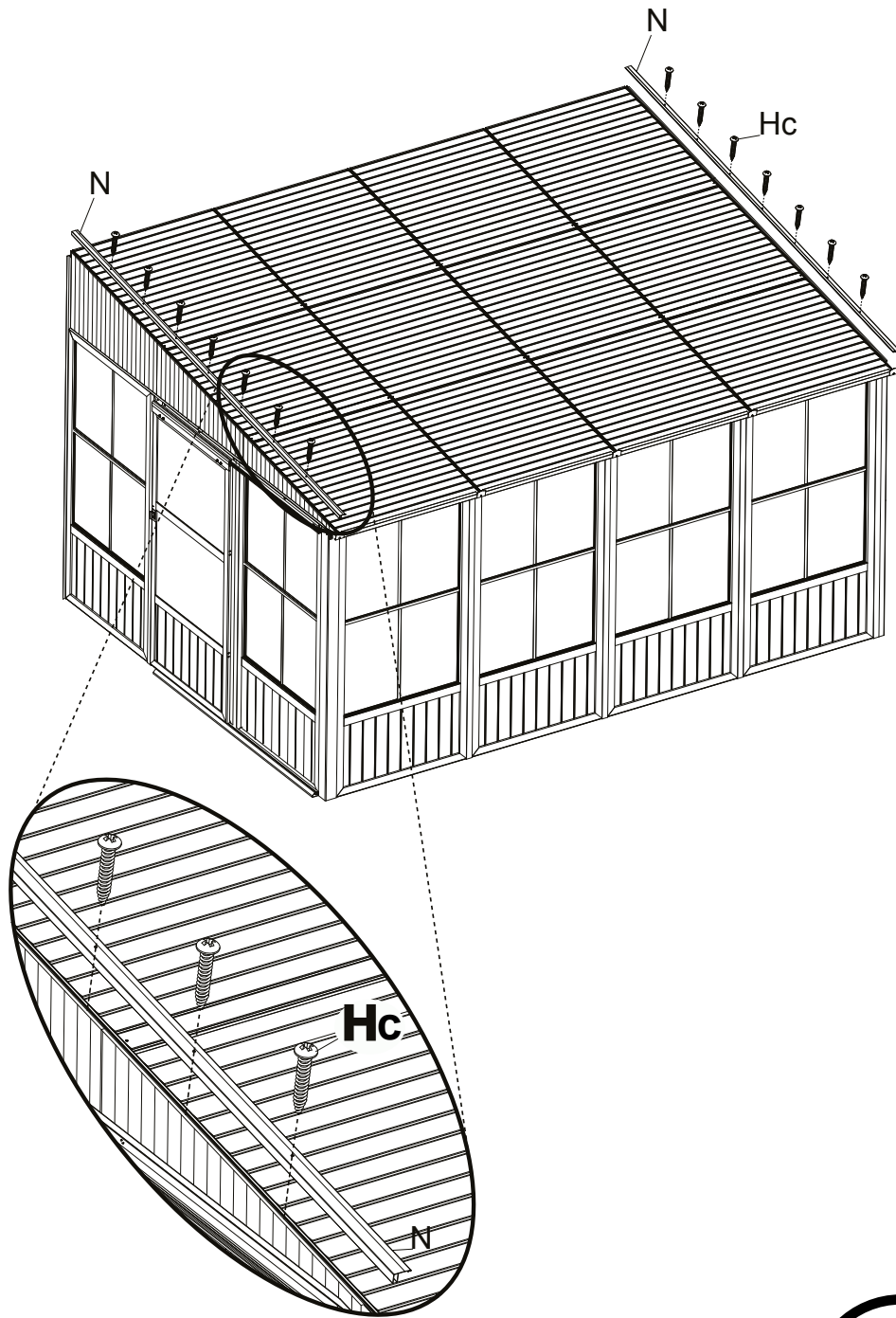

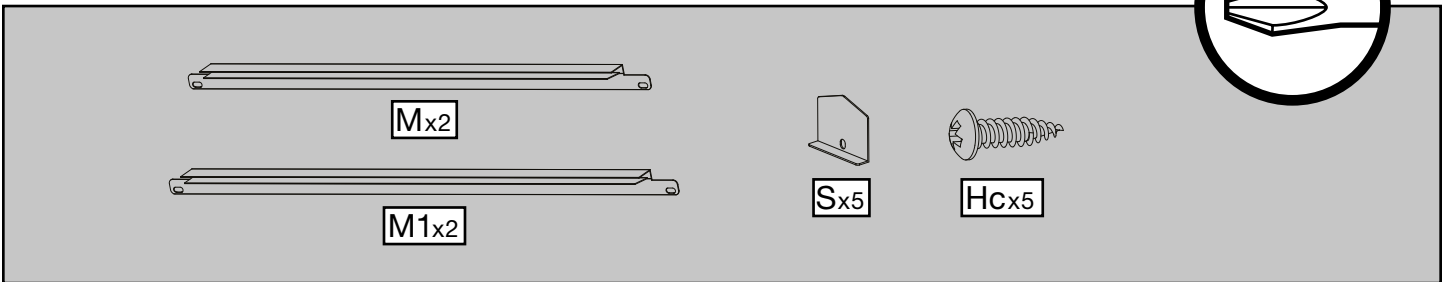
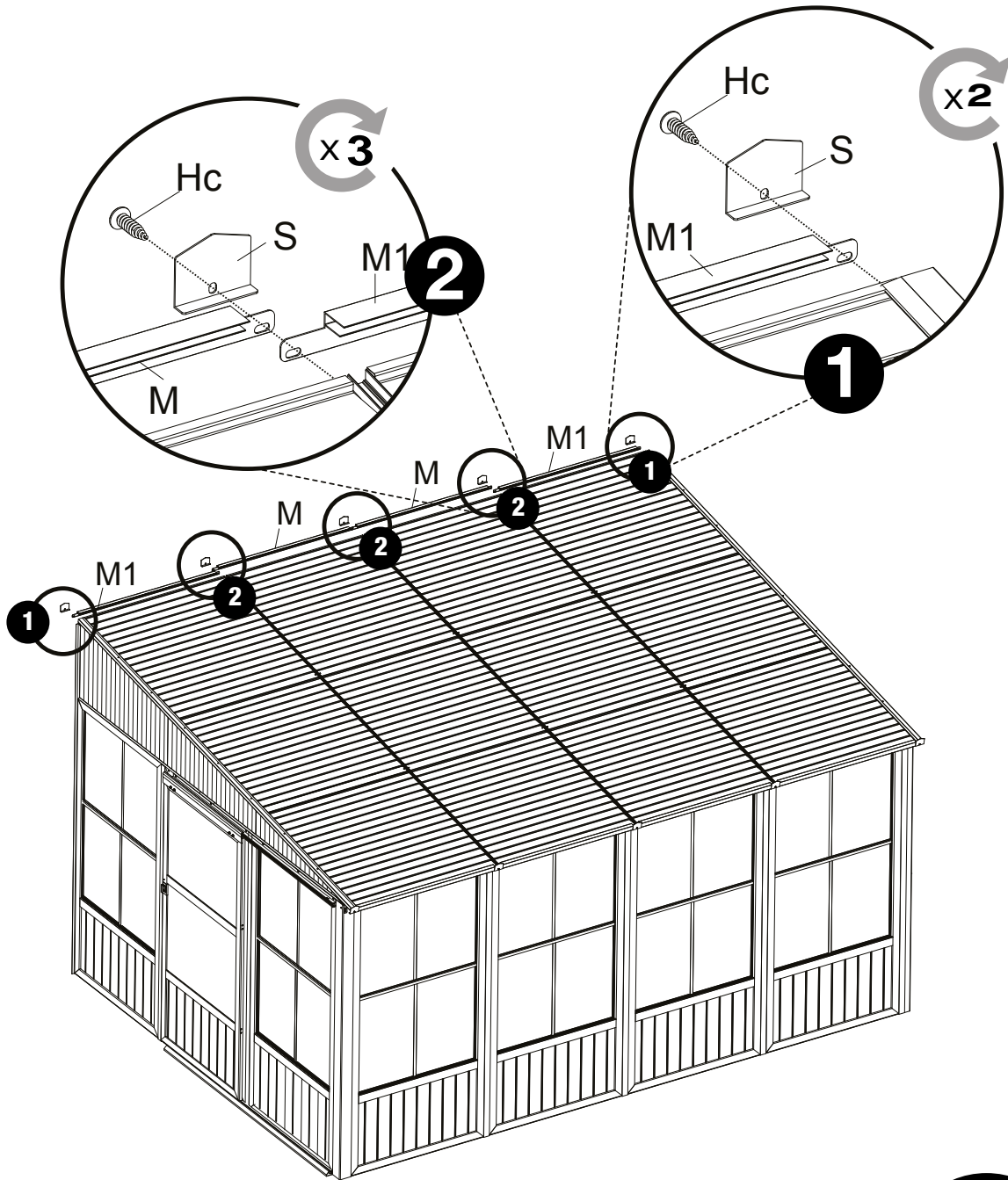

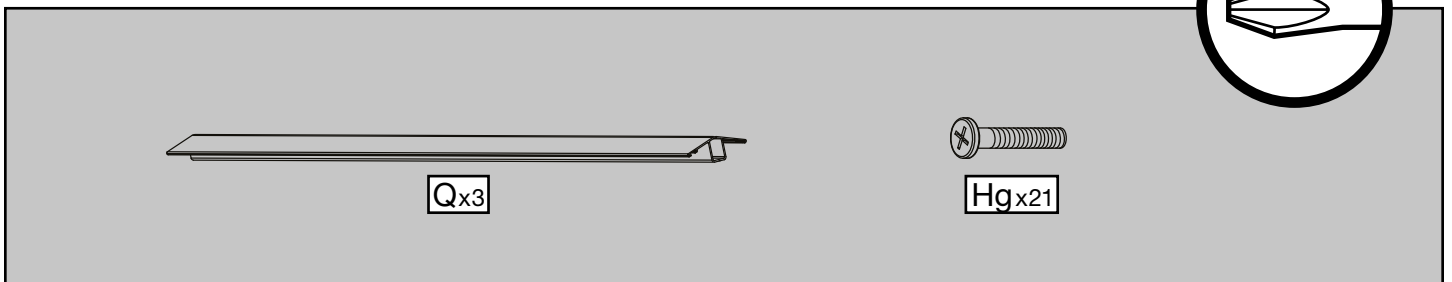
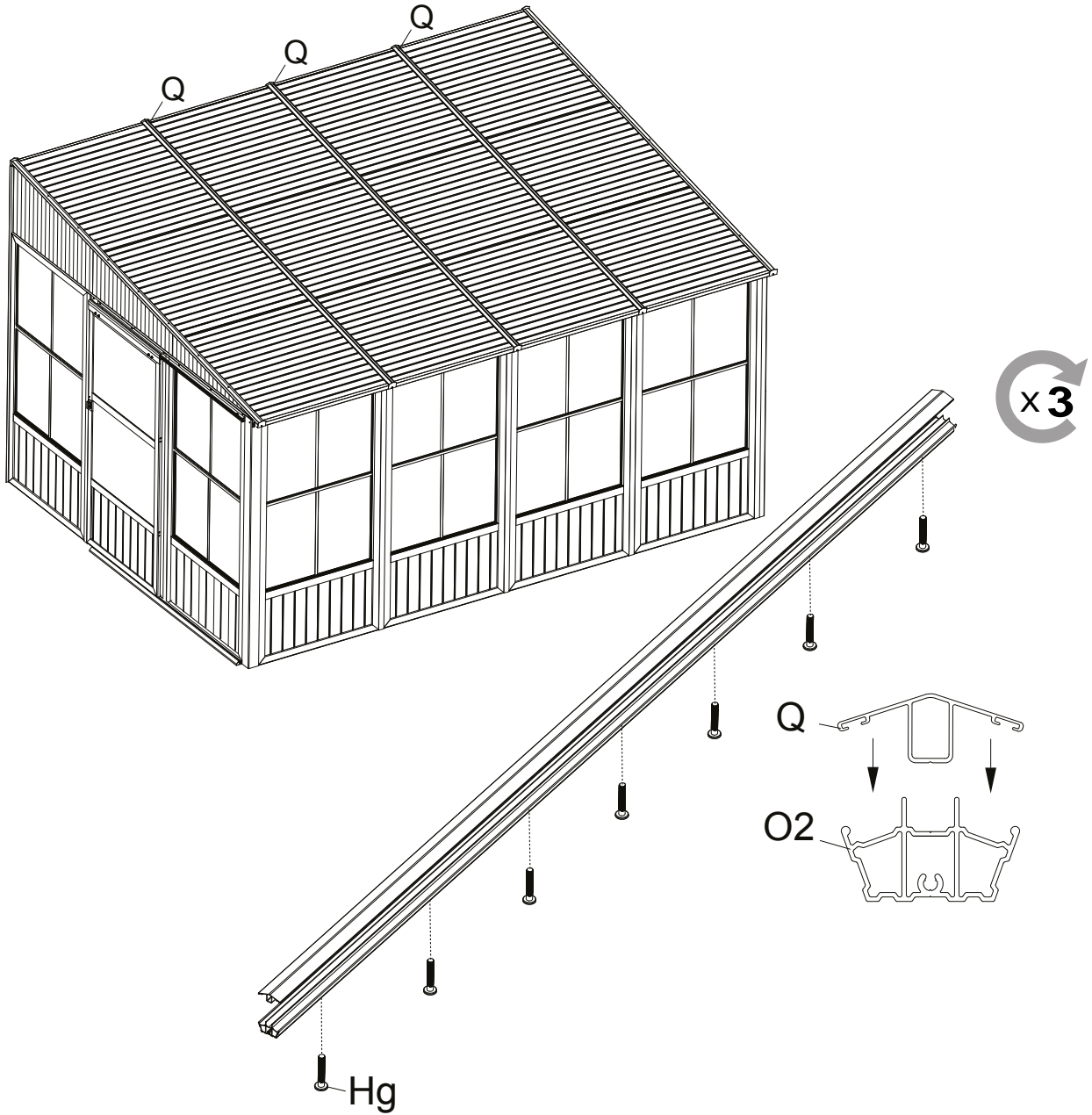







**SOJAG** ■ I  
produits saisonniers • seasonal products