

# TECHNICAL DATA SHEET MODEL O565

FICHE TECHNIQUE MODÈLE O565



**WEIGHT :** 4 131 lb Full, 816 lb Empty  
(POIDS) 1 874 kg Rempli, 370 kg Vide

**VOLUME :** 396 gal  
1 500 litres

**DIMENSIONS :** 87»x87»x36»  
221x221x91 cm

## TOP VIEW VUE DU DESSUS

TOLÉRANCE ± 0.5" ( 1,27 cm )

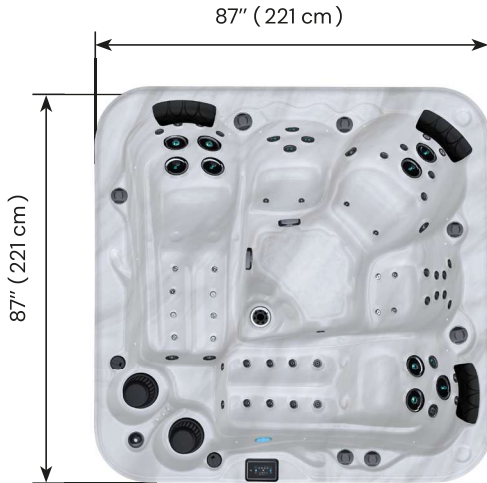

## SIDE VIEW VUE DE CÔTÉ

TOLÉRANCE ± 0.5" ( 127 mm )



## SKIRT VIEW VUE DE L'HABILLAGE

TOLÉRANCE ± 0.5" ( 1,27 cm )

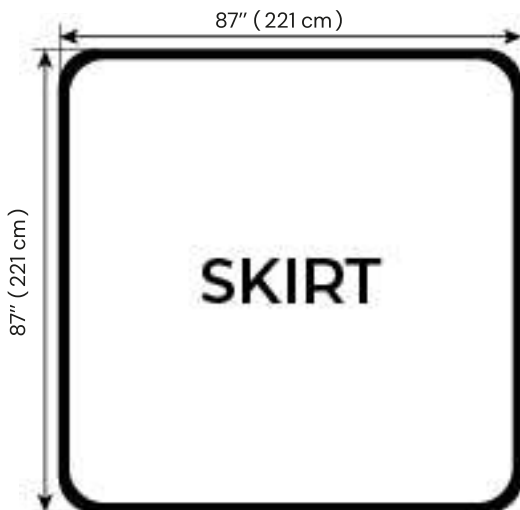

## BOTTOM VIEW ABS VUE DU DESSOUS ABS

TOLÉRANCE ± 0.5" ( 1,27 cm )

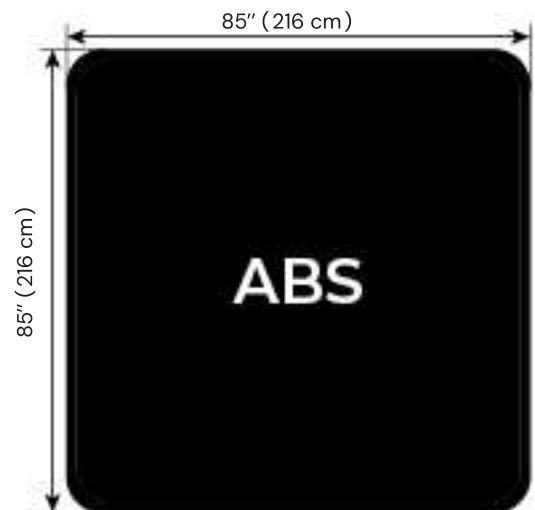

**IMPORTANT! Always measure each hot tub for exact dimensions BEFORE designing its foundational support and/or decking.**

IMPORTANT! Mesurez toujours les dimensions exactes de chaque spa AVANT de concevoir son support de fondation et/ou sa terrasse.

**DIMENSIONS/SPECIFICATIONS SUBJECT TO CHANGE WITHOUT NOTICE.**

**TOLERANCE ± 0.5" ( 1,27CM )**

DIMENSIONS/SPECIFICATIONS SUJETTES À CHANGEMENT SANS PRÉAVIS. TOLÉRANCE ± 0,5" ( 1,27 CM )



**JETS : 66**



**WATER & AIR JETS**  
**JETS D'EAU & AIR**

- 17  **2" DIRECTIONAL**  
2" DIRECTIONNEL
- 14  **2" ROTATIONAL**  
2" ROTATIONNEL
- 4  **3" DIRECTIONAL**  
3" DIRECTIONNEL
- 6  **3" ROTATIONAL**  
3" ROTATIONNEL
- 4  **5" DIRECTIONAL**  
5" DIRECTIONNEL
- 2  **5" ROTATIONAL**  
5" ROTATIONNEL
- 3  **5" ROTOPULSE**  
5" ROTOPULSEUR
- 16  **AIR JETS**  
JETS D'AIR

**VALVE CONTROL**  
**CONTRÔLE DES VALVES**

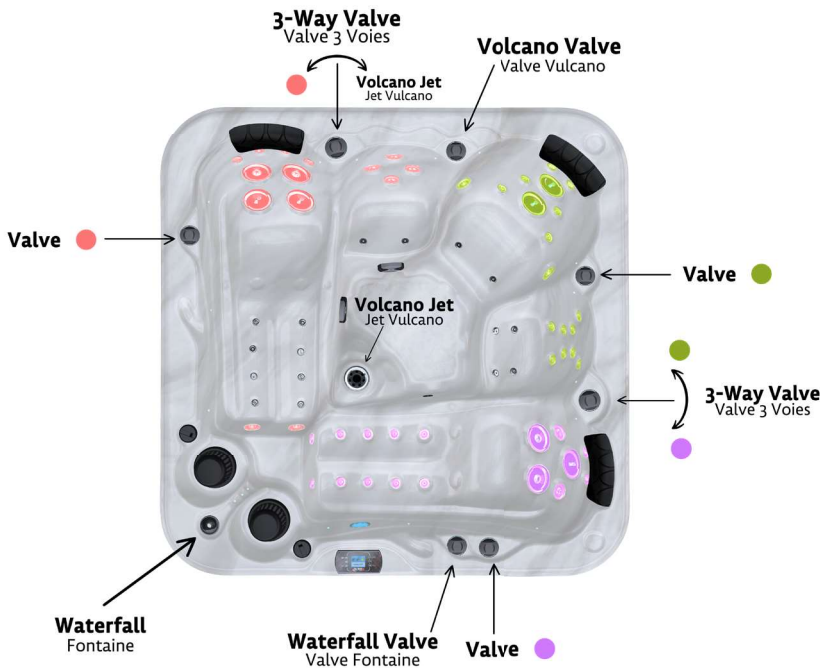

- PUMP - 2 SPEEDS** ● ●  
**POMPE - 2 VITESSES**
- PUMP - 1 SPEED** ●  
**POMPE - 1 VITESSE**
- BLOWER**  
**BLOWER**

# ELECTRICAL COMPONENT LAYOUT O565

## DISPOSITION DES COMPOSANTES ÉLECTRIQUES O565



**ELECTRICITY : 240 V | GFCI 60 A**  
**ÉLECTRICITÉ : 240 V | GFCI 60 A**

### MANAGEMENT CONNECTION CABLE

#### PASSAGE DU CÂBLE D'ALIMENTATION

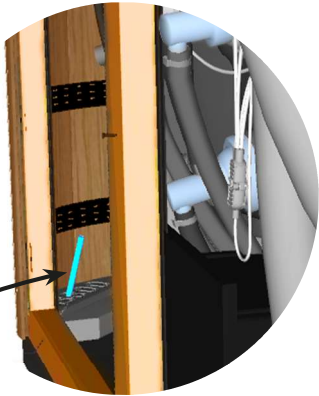

**Drill in the corner from inside to outside**  
Percer en angle de l'intérieur vers l'extérieure

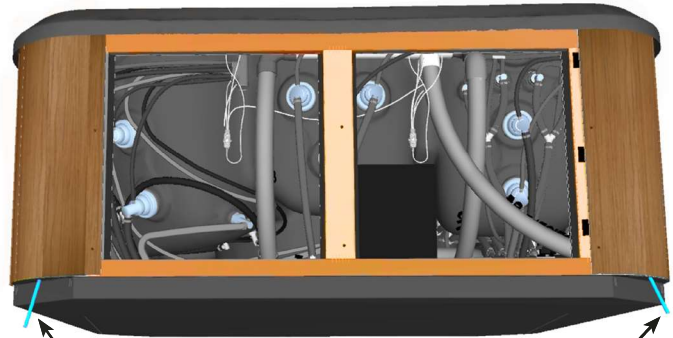

**One way or the other**  
D'un côté ou de l'autre

### COMPONENTS LAYOUT

#### DISPOSITION DES COMPOSANTES

### CAPTION

#### LÉGENDE

- 1. TouchScreen Keypad**  
Écran Tactile
- 2. Skimmer**  
Écumoire
- 3. Pack Gecko YE5**
- 4. Blower 120/230volt 7A/3A**  
Pompe à air 120/230volt 7A/3A
- 5. Pump 2 Speeds**  
Pompe bi-vitesse
- 6. Pump Single Speed**  
Pompe mono-vitesse

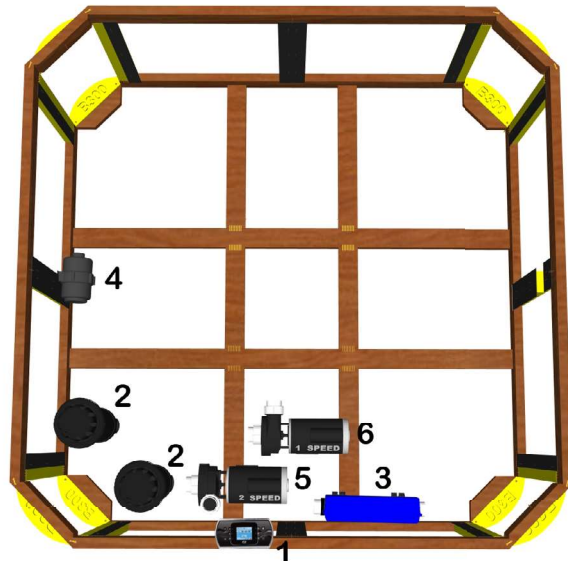

# TECHNICAL DATA SHEET MODEL O565 ( SANS VOLCANO )

FICHE TECHNIQUE MODÈLE O565 ( SANS VOLCANO )



**WEIGHT :** 4 131 lb Full, 816 lb Empty  
(POIDS) 1 874 kg Rempli, 370 kg Vide

**VOLUME :** 396 gal  
1 500 litres

**DIMENSIONS :** 87»x87»x36»  
221x221x91 cm

## TOP VIEW VUE DU DESSUS

TOLÉRANCE ± 0.5" ( 1,27 cm )

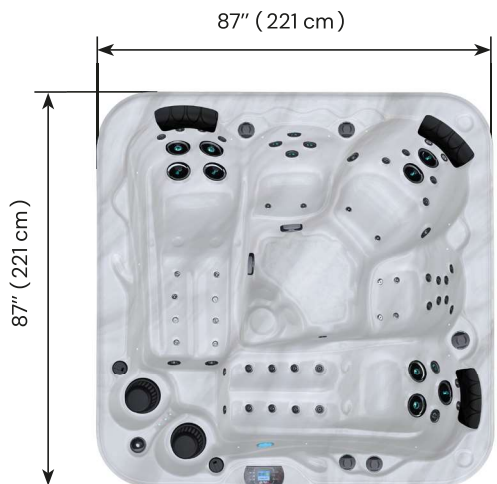

## SIDE VIEW VUE DE CÔTÉ

TOLÉRANCE ± 0.5" ( 127 mm )



## SKIRT VIEW VUE DE L'HABILLAGE

TOLÉRANCE ± 0.5" ( 1,27 cm )

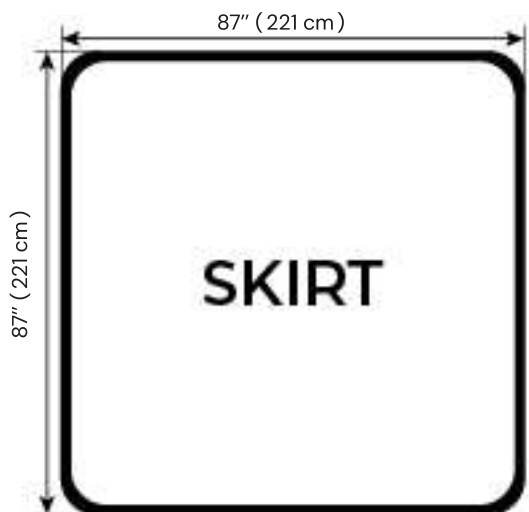

## BOTTOM VIEW ABS VUE DU DESSOUS ABS

TOLÉRANCE ± 0.5" ( 1,27 cm )

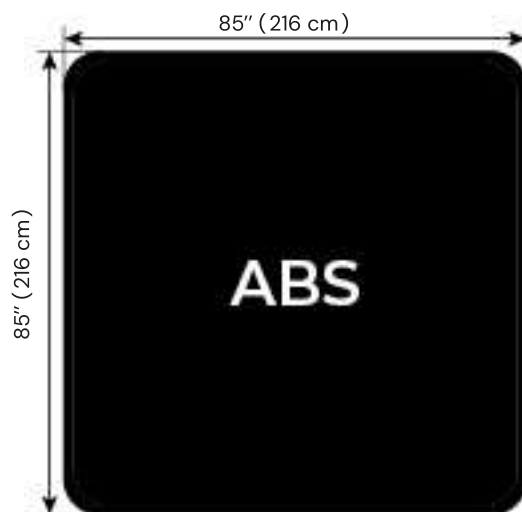

**IMPORTANT! Always measure each hot tub for exact dimensions BEFORE designing its foundational support and/or decking.**

IMPORTANT! Mesurez toujours les dimensions exactes de chaque spa AVANT de concevoir son support de fondation et/ou sa terrasse.

**DIMENSIONS/SPECIFICATIONS SUBJECT TO CHANGE WITHOUT NOTICE.**

**TOLERANCE ± 0.5" ( 1,27CM )**

DIMENSIONS/SPECIFICATIONS SUJETTES À CHANGEMENT SANS PRÉAVIS. TOLÉRANCE ± 0,5" ( 1,27 CM )



**JETS : 66**



**WATER & AIR JETS**  
 JETS D'EAU & AIR

- 17  2" DIRECTIONAL  
2" DIRECTIONNEL
- 14  2" ROTATIONAL  
2" ROTATIONNEL
- 4  3" DIRECTIONAL  
3" DIRECTIONNEL
- 6  3" ROTATIONAL  
3" ROTATIONNEL
- 4  5" DIRECTIONAL  
5" DIRECTIONNEL
- 2  5" ROTATIONAL  
5" ROTATIONNEL
- 3  5" ROTOPULSE  
5" ROTOPULSEUR
- 16  AIR JETS  
JETS D'AIR

**VALVE CONTROL**  
 CONTRÔLE DES VALVES

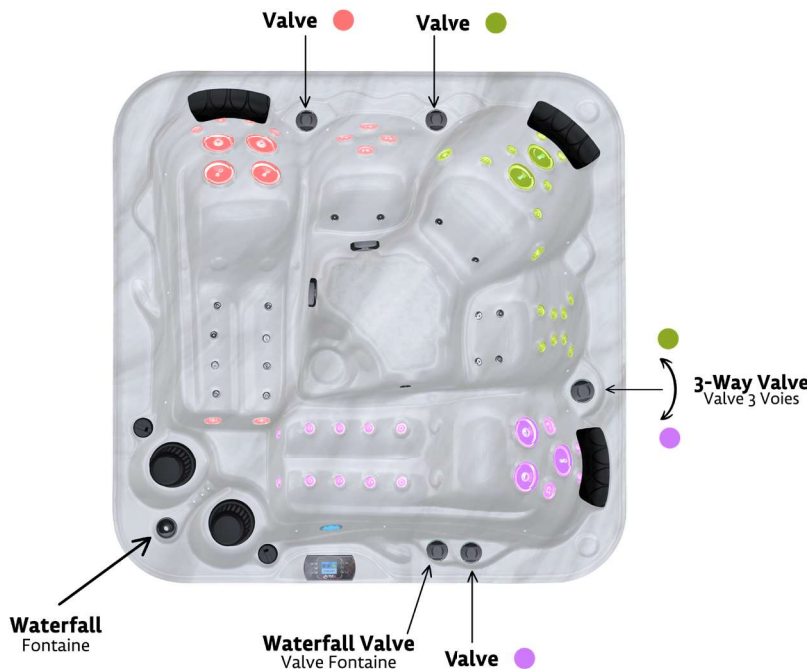

- PUMP - 2 SPEEDS ● ●  
 POMPE - 2 VITESSES
- PUMP - 1 SPEED ●  
 POMPE - 1 VITESSE
- BLOWER ●  
 BLOWER

# ELECTRICAL COMPONENT LAYOUT O565 ( SANS VOLCANO ) DISPOSITION DES COMPOSANTES ÉLECTRIQUES O565 ( SANS VOLCANO )

ELECTRICITY : 240 V | GFCI 60 A  
ÉLECTRICITÉ : 240 V | GFCI 60 A



## MANAGEMENT CONNECTION CABLE PASSAGE DU CÂBLE D'ALIMENTATION

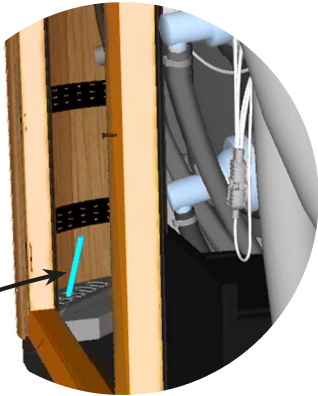

Drill in the corner from inside to outside  
Percer en angle de l'intérieur vers l'extérieure

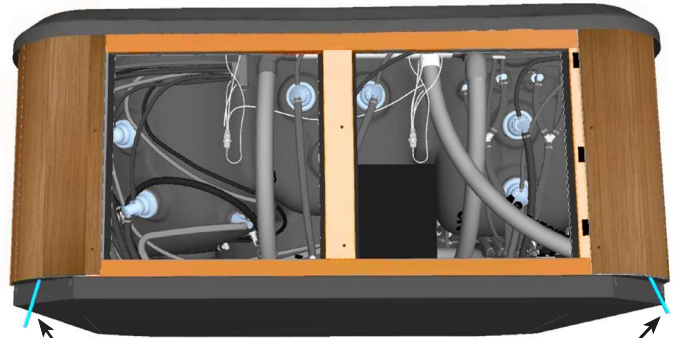

One way or the other  
D'un côté ou de l'autre

## COMPONENTS LAYOUT DISPOSITION DES COMPOSANTES

### CAPTION

#### LÉGENDE

1. TouchScreen Keypad  
Écran Tactile
2. Skimmer  
Écumoire
3. Pack Gecko YE5
4. Blower 120/230volt 7A/3A  
Pompe à air 120/230volt 7A/3A
5. Pump 2 Speeds  
Pompe bi-vitesse
6. Pump Single Speed  
Pompe mono-vitesse

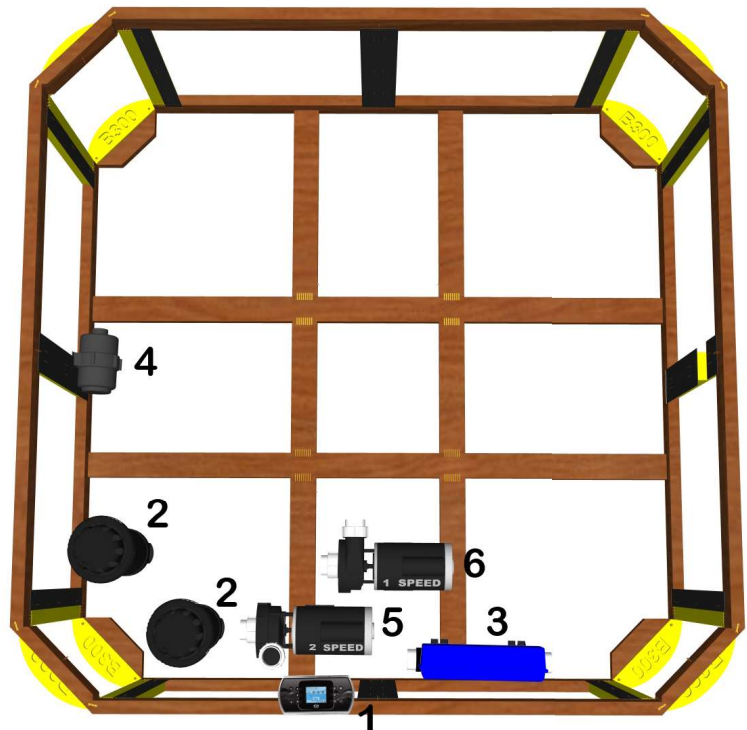

# TECHNICAL DATA SHEET MODEL O565 K1000

## FICHE TECHNIQUE MODÈLE O565 K1000



**WEIGHT :** 4 131 lb Full, 816 lb Empty  
(POIDS) 1 874 kg Rempli, 370 kg Vide

**VOLUME :** 396 gal  
1 500 litres

**DIMENSIONS :** 87»x87»x36»  
221x221x91 cm

### TOP VIEW VUE DU DESSUS

TOLÉRANCE ± 0.5" ( 1,27 cm )

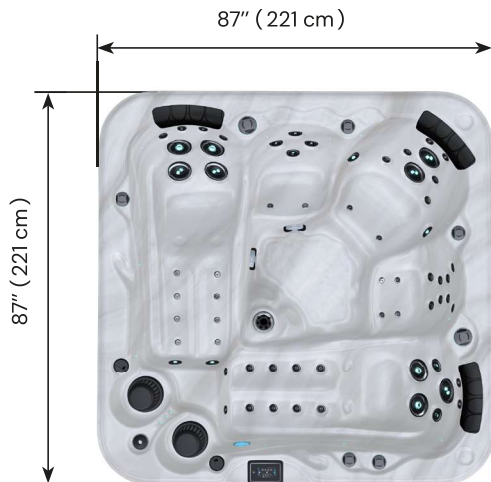

### SIDE VIEW VUE DE CÔTÉ

TOLÉRANCE ± 0.5" ( 127 mm )



### SKIRT VIEW VUE DE L'HABILLAGE

TOLÉRANCE ± 0.5" ( 1,27 cm )

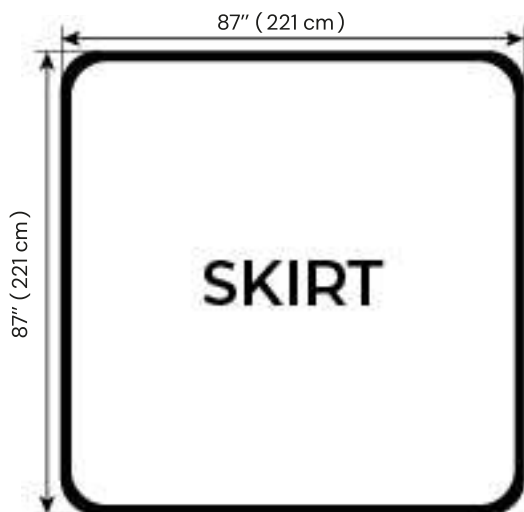

### BOTTOM VIEW ABS VUE DU DESSOUS ABS

TOLÉRANCE ± 0.5" ( 1,27 cm )

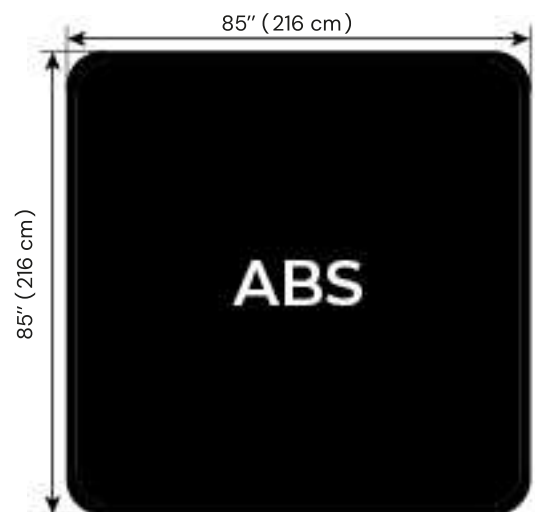

**IMPORTANT! Always measure each hot tub for exact dimensions BEFORE designing its foundational support and/or decking.**

IMPORTANT! Mesurez toujours les dimensions exactes de chaque spa AVANT de concevoir son support de fondation et/ou sa terrasse.

**DIMENSIONS/SPECIFICATIONS SUBJECT TO CHANGE WITHOUT NOTICE.**

**TOLERANCE ± 0.5" ( 1,27CM )**

DIMENSIONS/SPECIFICATIONS SUJETTES À CHANGEMENT SANS PRÉAVIS. TOLÉRANCE ± 0,5" ( 1,27 CM )



**JETS : 66**

**WATER & AIR JETS**  
**JETS D'EAU & AIR**



- 17  **2" DIRECTIONAL**  
2" DIRECTIONNEL
- 14  **2" ROTATIONAL**  
2" ROTATIONNEL
- 4  **3" DIRECTIONAL**  
3" DIRECTIONNEL
- 6  **3" ROTATIONAL**  
3" ROTATIONNEL
- 4  **5" DIRECTIONAL**  
5" DIRECTIONNEL
- 2  **5" ROTATIONAL**  
5" ROTATIONNEL
- 3  **5" ROTOPULSE**  
5" ROTOPULSEUR
- 16  **AIR JETS**  
JETS D'AIR

**VALVE CONTROL**  
**CONTRÔLE DES VALVES**

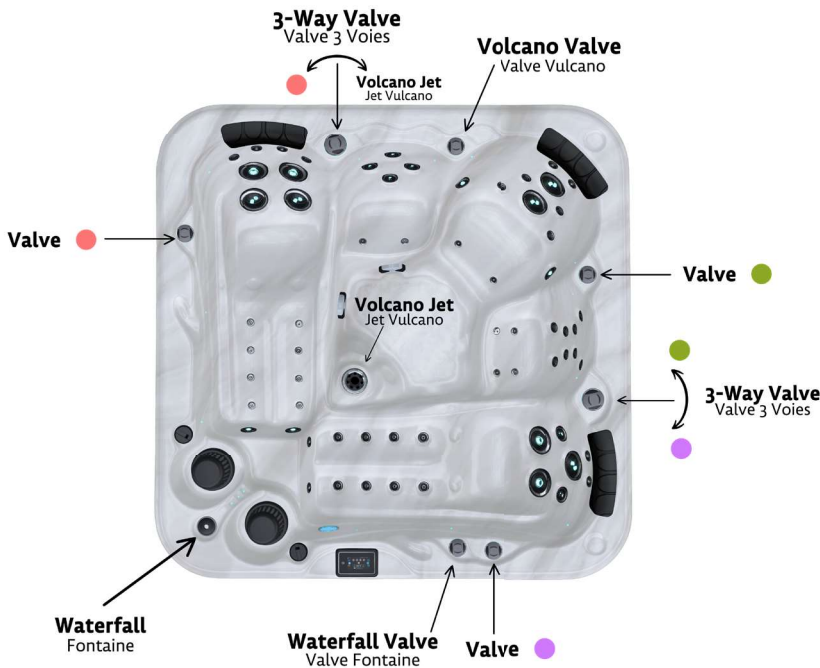

- PUMP - 2 SPEEDS** ● ●  
**POMPE - 2 VITESSES**
- PUMP - 1 SPEED** ●  
**POMPE - 1 VITESSE**
- BLOWER**  
**BLOWER**



# ELECTRICAL COMPONENT LAYOUT O565 K1000

## DISPOSITION DES COMPOSANTES ÉLECTRIQUES O565 K1000



**ELECTRICITY : 240 V | GFCI 60 A**  
**ÉLECTRICITÉ : 240 V | GFCI 60 A**

### MANAGEMENT CONNECTION CABLE

#### PASSAGE DU CÂBLE D'ALIMENTATION

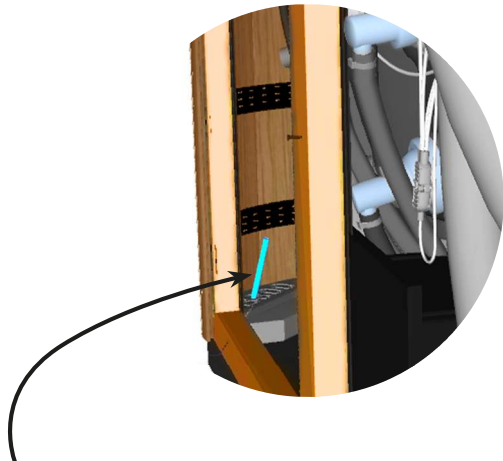

**Drill in the corner from inside to outside**  
Percer en angle de l'intérieur vers l'extérieure

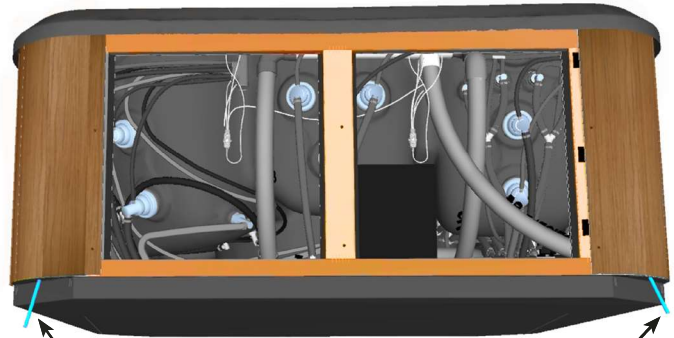

**One way or the other**  
D'un côté ou de l'autre

### COMPONENTS LAYOUT

#### DISPOSITION DES COMPOSANTES

### CAPTION

#### LÉGENDE

- 1. TouchScreen Keypad**  
Écran Tactile
- 2. Skimmer**  
Écumoire
- 3. Pack Gecko YE5**
- 4. Blower 120/230volt 7A/3A**  
Pompe à air 120/230volt 7A/3A
- 5. Pump 2 Speeds**  
Pompe bi-vitesse
- 6. Pump Single Speed**  
Pompe mono-vitesse

